

DERC
SALOTECH

**PRODUCT
CATALOGUE**



Water Jetting Equipment

FOR INDUSTRIAL CLEANING & SURFACE PREPARATION

Table of Contents

Water Jetting Equipment for Industrial Cleaning & Surface Preparation	4
Combined Forces	6
Our Partners	8
Products	10
Tube Bundle Cleaning	12
DERC Runner Nozzle	12
DERC Rotating Nozzle Spin-Jet	16
DERC Nozzles	18
DERC Shell Side Blaster SSB	20
DERC Tube Bundle Rollers	22
DERC Rotating Coupling Swivel RCS-200	24
DERC Rigid Lance Cleaner RLC	26
DERC Blast Container	30
Pipe Cleaning	32
DERC R-Tube	32
DERC Rotating Pipe Cleaner RPC	36
DERC Speed Regulated Line Cleaner SLC	38
DERC RotoCar Cleaning System	42
DERC Speed Regulated Pipe Cleaner SPC	44
DERC Speed Regulated Pipe Cleaner SPC-UH	48
DERC Centralizers	50
Swivels	52
DERC Rotary Coupling Swivel RCS UHS	52
DERC Rotary Coupling Swivel RCS UHS Mini	54
DERC Rotary Coupling Swivel RCS Mini	56
DERC Rotary Coupling Swivel RCS-44	58
DERC Rotary Coupling Swivel RCS-75	60
Tank Cleaning	62
DERC Mini Turret	62
DERC Tank Cleaning Tools	64
Abrasive Cutting	66
DERC Abrasive Cutting System Flexa-Jet	66
Surface Cleaning	72
DERC MagTrack	72
DERC Hydro-Jet Mower	76
DERC Rotary Coupling Swivel RCS-500	78
RD Masterjet	80
Monro-Jet Nozzles	81

Table of Contents

Automated Solutions	82
DERC Hydraulic Hose Reel	82
DERC Air PreHeater Cleaner APC	84
NEW DERC Scaffold Cleaner	86
Hoses	88
DERC Hydroblast 4+ Hose	88
SPIR STAR Hoses	90
Safety Products	92
DERC Hose Catchers	92
DERC Hose Safety Systems	96
DERC Warning Sign Water Jetting	98
Guns & Foot Valves	100
Guns & Foot Valves	100
Nozzles	106
Nozzles	106
Paper-Jet Nozzles	116
Accessories	118
DERC Adapters, Manifolds & Nozzle Holders	118
DERC Rupture Disc Holder	126
Rupture Disc	127
DERC Automated Solutions Rail ASR	128
DERC Pre-Filter	130
DERC Lances	132
DERC Stingers	133
DERC Short 90° Elbows	134
Quick Connectors	134
DERC Long Radius Elbows	135
Connectors & Cables	136
Emergency Stops, Remotes & Reels	137
Sewer Cleaning	138
Sewer Cleaning Nozzles	138
DERC Sewer Razor	140

Imprint

All rights reserved, reproduction in part or in whole is only permitted with the publisher's consent. Errors and omissions excepted. Illustrations and photos may differ. No liability for misprints is accepted.

Publisher:
DERC Salotech
Jan van der Heijdenstraat 44
3261 LE Oud-Beijerland



Water Jetting Equipment for Industrial Cleaning & Surface Preparation

DEDICATED SINCE 1985

DERC Salotech offers total solutions, systems and all necessary accessories for high pressure water jetting. With 39 years of dedication to the high pressure water jetting technology for industrial cleaning and surface preparation, we are a quality partner for professionals all over the world.

DERC Salotech services thousands of customers and organizations in more than 40 countries. As an original water jetting equipment manufacturer we continuously design, develop and produce new products and innovations that will make your job easier, safer and more effective.



WATER JETTING TOOLS

Whatever your needs for industrial cleaning or surface preparation are, DERC Salotech offers the right high pressure water jetting tools for the job. Our products are considered to be industry leading in innovation, quality and durability.

We offer everything from hand-held waterjet guns to fully automated solutions for cleaning tubes, pipes, surfaces, (oil) storage tanks and sewers. Thoroughly tested and certified to ensure safe and effective operation.

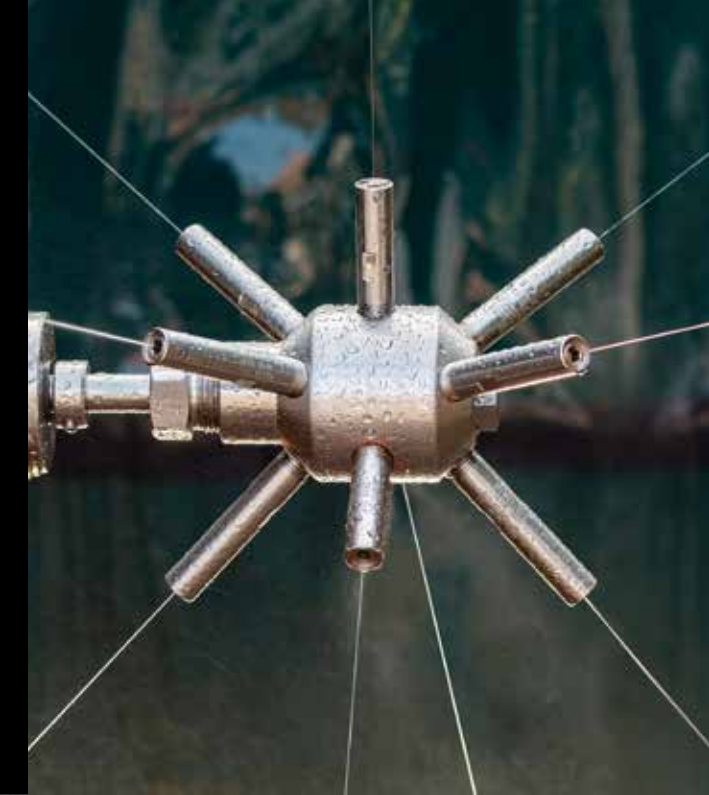

**MADE BY
DERC**

CUSTOM MADE SOLUTIONS

If it doesn't exist, DERC Salotech will invent it for you! Does your industrial cleaning objective requires a custom solution? Our engineers are committed to find the most suitable solution for your challenge. High pressure water jetting and innovation is part of our DNA.

Our engineers are ready to assist you, no matter how big or small the technical, process or safety challenges are. During the research, design and manufacturing we will focus on the most effective and (when appropriate) most innovative and safe cleaning solutions for your specific needs.





DERC SALOTECH

DERC Salotech operates as our front office internationally and operates from two locations in the Netherlands (Oud-Beijerland) and Germany (Seevetal). Our unique Made by DERC products are manufactured at our headquarters in the Netherlands.

DERC Salotech is recognised worldwide as an innovative and leading partner in the high pressure water jetting industry. No matter what your request is in the field of high pressure water jetting and industrial cleaning: your needs and interests are our mission. Our skilled staff and experts are completely committed to this mission; wherever you are and whatever your challenge or budget is.



Combined Forces

DERC Salotech and DERC Adviesgroep are both subsidiaries of DERC Waterjetting. Combining forces, there is strong focus on promoting the water jetting technology, how to use it safely and servicing our customers.



DERC ADVIESGROEP

DERC Adviesgroep offers a complete range of SIR and WJA courses in water jetting and industrial cleaning.

For 20 years, our independent knowledge center in Stellendam, Netherlands, has prioritized safety. Our mission is to promote knowledge and enhance safety in the water jetting field.

Visit the DERC Adviesgroep website to explore our course offerings (scan QR code).



TST SWEDEN

TST offers a complete assortment of personnel protection equipment of the highest standard for hydro demolition, water jetting and blasting at (ultra) high pressures. Their clothes are developed to offer the best possible comfort, while at the same time protecting operators from the impact of water jets up to 3000 bar.



SAVING LIVES



Our Partners

Together with our trusted partners we offer a complete range of water jetting products, accessories and solutions

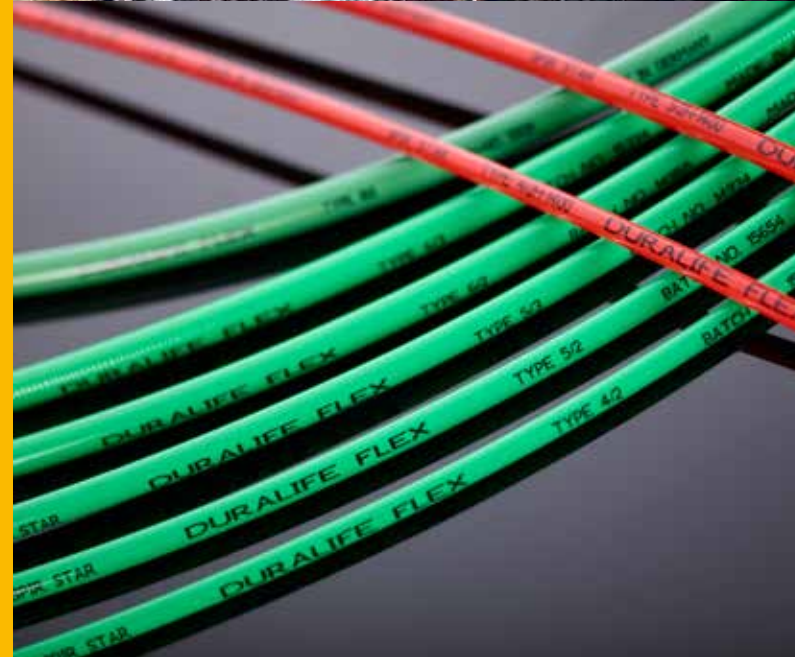

SPIR STAR AUTHORIZED DEALER & ASSEMBLY CENTER



PEINEMANN

Peinemann offers state-of-the-art semi-automated bundle cleaning systems in order to clean heat exchangers in the safest and most effective way possible.



SPIR STAR

The German leading specialist in the production of high-pressure hoses with a spiralized support made of high-tensile steel wires for use in a pressure range of 400 to 4000 bar.



DERC Products

MADE BY
DERC



DERC Runner Nozzle

DERC Runner Nozzle

Scan for more info



FAST DELIVERY



PERFECT 360° CLEANING OF HEAT EXCHANGERS

The DERC Runner Nozzle is a rotating tube cleaning nozzle designed for cleaning heat exchanger tubes, with a maximum working pressure of 1500 bar/22K PSI.

Four Sizes

The Runner Nozzle comes in 4 available sizes: Ø 10 mm, Ø 13 mm, Ø 18 mm and Ø 24 mm.

Three Types of Nozzle Heads

The Runner Nozzle is available with standard, unplugging and polisher nozzle heads to remove hard plugs or scales.



FEATURES

- High efficiency jets, recessed drilled
- Uniquely shaped nozzle head for improved cleaning & unplugging
- Standard, polisher or unplugging nozzle head
- Patented design
- Hardened body
- Metric wrench flats
- Hardened inlet cover to improve mechanical wear and tear
- Various connections

APPLICATION

- Cleaning heat exchanger tubes
- Cleaning evaporator tubes
- Cleaning tubes and pipes

RUNNER 10 - DIAMETER Ø 10 MM - LENGTH 60 MM

Connection	Max. Pressure	Part No.
M7x1 - Female	1500 bar / 22K	RUN10-M7F-3
5/16" UNF - Male (65mm)	1500 bar / 22K	RUN10-516M-3
1/16" NPT - Female	1000 bar / 15K	RUN10-116NF-3
1/4" UNF LH - Female	1500 bar / 22K	RUN10-M4LF-3
1/4" UNF RH - Female	1500 bar / 22K	RUN10-M4RF-3

RUNNER 13 - DIAMETER Ø 13 MM - LENGTH 75 MM

Connection	Max. Pressure	Part No.
1/8" BSP - Female	1500 bar / 22K	RUN13-18F-3
1/8" NPT - Female	1000 bar / 15K	RUN13-18NF-3
3/8" UNF LH - Female	1500 bar / 22K	RUN13-M6LF-3
3/8" UNF RH - Female	1500 bar / 22K	RUN13-M6RF-3

RUNNER 18 - DIAMETER Ø 18 MM - LENGTH 101 MM

Connection	Max. Pressure	Part No.
1/4" BSP - Female	1500 bar / 22K	RUN18-14F-2
1/4" NPT - Female	1000 bar / 15K	RUN18-14NF-2
9/16" UNF LH - Female	1500 bar / 22K	RUN18-M9LF-2
9/16" UNF RH - Female	1500 bar / 22K	RUN18-M9RF-2

RUNNER 24 - DIAMETER Ø 24 MM - LENGTH 134 MM

Connection	Max. Pressure	Part No.
3/8" BSP - Female	1500 bar / 22K	RUN24-38F
3/8" NPT - Female	1000 bar / 15K	RUN24-38NF
9/16" UNF LH - Female	1500 bar / 22K	RUN24-M9LF
9/16" UNF RH - Female	1500 bar / 22K	RUN24-M9RF

DERC Runner Nozzle

RUNNER 10			
Part No.	Type	Max. Pressure	Flow
RUN10-025B-S1	Standard	1000-1500 bar / 15-22K	24-30 lpm / 6.5-8 gpm
RUN10-025B-U1	Unplugger	700-1000 bar / 10-15K	19-23 lpm / 5-6 gpm
RUN10-025B-U2	Unplugger	1000-1500 bar / 15-22K	21-25 lpm / 5.5-6.5 gpm
RUN10-025B-P1	Polisher	700-1000 bar / 10-15K	17-21 lpm / 4.5-5.5 gpm
RUN10-025B-P2	Polisher	1000-1500 bar / 15-22K	19-23 lpm / 5-6 gpm

RUNNER 13			
Part No.	Type	Max. Pressure	Flow
RUN13-025B-S1	Standard	700-1000 bar / 10-15K	30-38 lpm / 8-10 gpm
RUN13-025B-S3	Standard	1000-1500 bar / 15-22K	30-38 lpm / 8-10 gpm
RUN13-025B-U1	Unplugger	700-1000 bar / 10-15K	27-34 lpm / 7-9 gpm
RUN13-025B-U3	Unplugger	1000-1500 bar / 15-22K	27-34 lpm / 7-9 gpm
RUN13-025B-P1	Polisher	700-1000 bar / 10-15K	27-34 lpm / 7-9 gpm
RUN13-025B-P3	Polisher	1000-1500 bar / 15-22K	27-34 lpm / 7-9 gpm

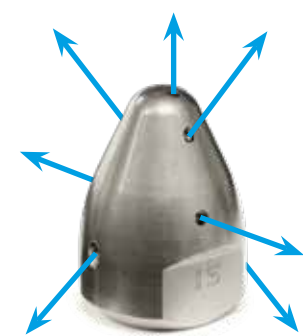

STANDARD HEAD

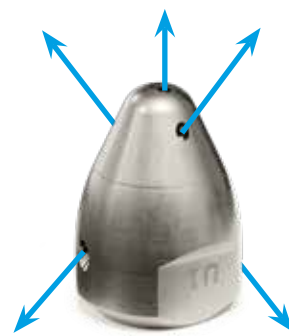

UNPLUGGER HEAD

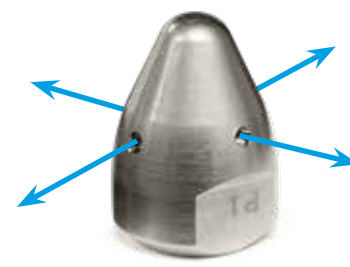

POLISHER HEAD

DERC Runner Nozzle

Scan for more info



RUNNER 18			
Part No.	Type	Max. Pressure	Flow
RUN18-025B-S1	Standard	700-1000 bar / 10-15K	42-53 lpm / 11-14 gpm
RUN18-025B-S2	Standard	700-1000 bar / 10-15K	30-38 lpm / 8-10 gpm
RUN18-025B-S3	Standard	1000-1500 bar / 15-22K	42-53 lpm / 11-14 gpm
RUN18-025B-U1	Unplugger	700-1000 bar / 10-15K	42-53 lpm / 11-14 gpm
RUN18-025B-U2	Unplugger	700-1000 bar / 10-15K	30-38 lpm / 8-10 gpm
RUN18-025B-U3	Unplugger	1000-1500 bar / 15-22K	42-53 lpm / 11-14 gpm
RUN18-025B-U4	Unplugger	1000-1500 bar / 15-22K	30-38 lpm / 8-10 gpm
RUN18-025B-P1	Polisher	700-1000 bar / 10-15K	42-53 lpm / 11-14 gpm
RUN18-025B-P2	Polisher	700-1000 bar / 10-15K	30-38 lpm / 8-10 gpm
RUN18-025B-P3	Polisher	1000-1500 bar / 15-22K	42-53 lpm / 11-14 gpm
RUN18-025B-P4	Polisher	1000-1500 bar / 15-22K	30-38 lpm / 8-10 gpm

RUNNER 24			
Part No.	Type	Max. Pressure	Flow
RUN24-025B-P1	Polisher	700-1000 bar / 10-15K	76-95 lpm / 20-25 gpm
RUN24-025B-P2	Polisher	700-1000 bar / 10-15K	57-72 lpm / 15-19 gpm
RUN24-025B-P3	Polisher	700-1000 bar / 10-15K	45-53 lpm / 12-14 gpm
RUN24-025B-P4	Polisher	1000-1500 bar / 15-22K	68-80 lpm / 18-21 gpm
RUN24-025B-P5	Polisher	1000-1500 bar / 15-22K	57-64 lpm / 15-17 gpm
RUN24-025B-P6	Polisher	1000-1500 bar / 15-22K	45-53 lpm / 12-14 gpm
RUN24-025B-S1	Standard	700-1000 bar / 10-15K	76-95 lpm / 20-25 gpm
RUN24-025B-S2	Standard	700-1000 bar / 10-15K	57-72 lpm / 15-19 gpm
RUN24-025B-S3	Standard	700-1000 bar / 10-15K	45-53 lpm / 12-14 gpm
RUN24-025B-S4	Standard	1000-1500 bar / 15-22K	68-80 lpm / 18-21 gpm
RUN24-025B-S5	Standard	1000-1500 bar / 15-22K	57-64 lpm / 15-17 gpm
RUN24-025B-S6	Standard	1000-1500 bar / 15-22K	45-53 lpm / 12-14 gpm

DERC Rotating Nozzle Spin-Jet



CLEANING HEAT EXCHANGER TUBES UP TO 1500 BAR

The DERC Spin-Jet nozzles are designed for cleaning heat exchanger tubes and pipelines using high-pressure water jetting technology.

Rotating Mechanism

The water flow and pressure from your high-pressure pump rotate the DERC Spin-Jets. DERC Salotech offers 5 different models.

Authenticity

All spinners are marked with Spin-Jet.com, ensuring they are original DERC Salotech products.

FEATURES

- Up to 1000/1500 bar
- Metric, BSP, NPT, MP RH or LH connections
- Perfect cleaning without "stripes"

APPLICATIONS

- General pipe and tube cleaning
- Heat exchanger cleaning

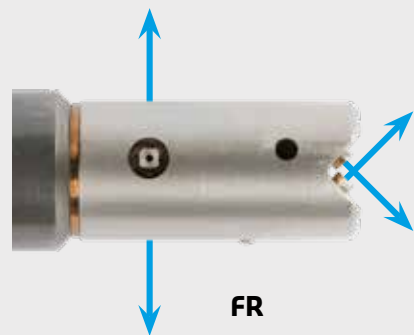

CALL US +31 186 - 62 14 84

DERC Rotating Nozzle Spin-Jet

Scan for more info



SPIN-JET SIBR			
Jet Angle	Diameter	Connection	Max. Pressure
2 x 90° Radial, 2 x 45° and optional front jet	8, 10, 12, 18, 28 and 40 mm	Metric, BSP, NPT, MP RH or LH	1500 bar
SPIN-JET SI			
Jet Angle	Diameter	Connection	Max. Pressure
4x 90° Radial and optional front jet	8, 10, 12, 18, 28 and 40 mm	Metric, BSP, NPT, MP RH or LH	1500 bar
SPIN-JET SISFBR			
Jet Angle	Diameter	Connection	Max. Pressure
2 x 10° Front 2 x 90° / 2 x 45°	10, 12, 18, 28 and 40 mm	Metric, BSP, NPT, MP RH or LH	1500 bar
SPIN-JET FR			
Jet Angle	Diameter	Connection	Max. Pressure
2 x Cross Jet Front 2 x 90° Radial	10, 12, 22, 31 and 46 mm	Metric, BSP, NPT, MP RH or LH	1000 bar
SPIN-JET R			
Jet Angle	Diameter	Connection	Max. Pressure
2x 90° Radial	10, 12, 22, 31 and 46 mm	Metric, BSP, NPT, MP RH or LH	1000 bar

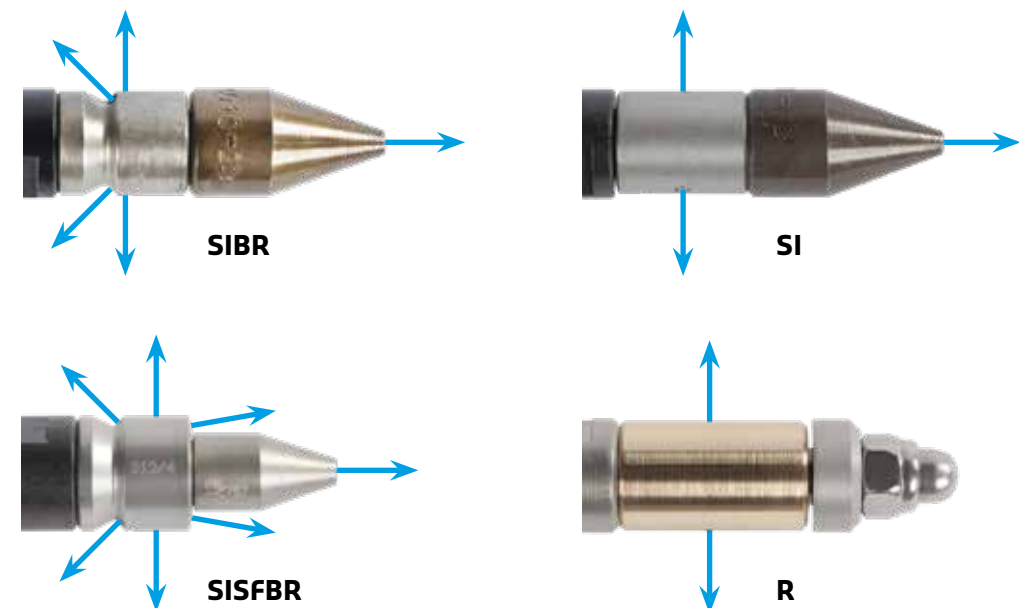

DERC Nozzles

FAST DELIVERY



THE PERFECT NOZZLE FOR ANY JOB - CONFIGURED TO YOUR SPECIFICATIONS

The DERC nozzle range is the basis for all your water jetting projects up to 3000 bar.

Made to Order

Our basic models simplify your choice, can be configured to your specifications, and delivered quickly.

Perfect Spray Patterns

Based on your requirements (pressure, pump capacity, use as pulling/pushing or neutral, permissible reaction force, and spray pattern), we advise on the optimal configuration, providing you with the perfect spray pattern for the best results.



DST

FEATURES

- Configured to your specifications
- High efficiency with optimum spray pattern
- Longer life cycle because of recessed drilled nozzle-holes and spray pattern
- No oxidation, due to applied materials and heat treatment
- Short delivery times
- Excellent value for money

APPLICATION

- High pressure cleaning of tubes and pipes

CALL US +31 186 - 62 14 84

DERC Nozzles

Scan for more info

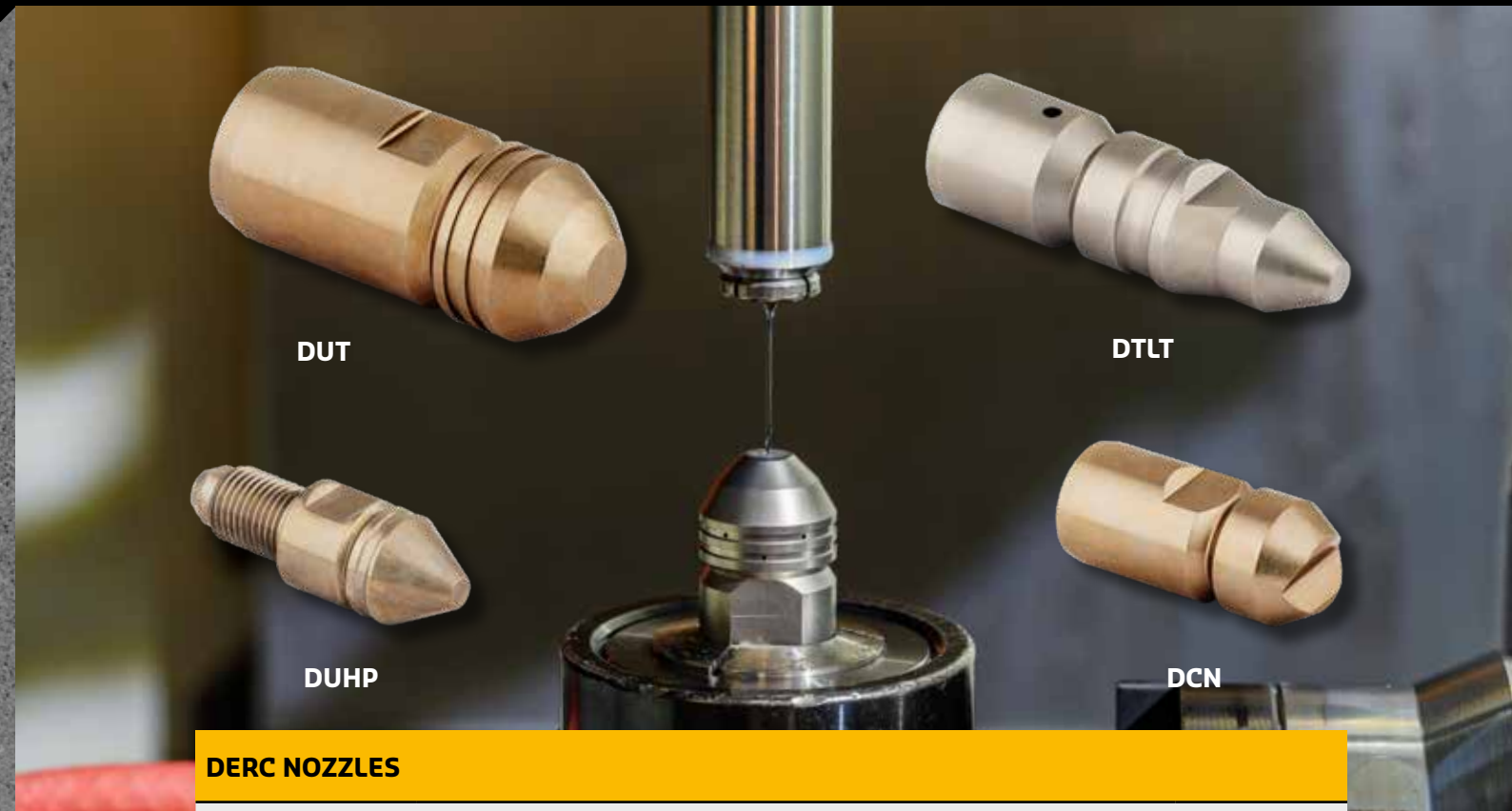

DERC NOZZLES

Part No.	Connection	Max. Pressure
DUT-Nozzle	M7x1 F 1/8" BSP F 1/4" BSP F 3/8" BSP F	1500 bar
DST-Nozzle	M7x1 F 1/8" BSP F 1/4" BSP F	1500 bar
DPT-Nozzle	M7x1 F 1/8" BSP F 1/4" BSP F	1500 bar
DPLT-Nozzle	1/4" - 28 UNF M 5/16" - 24 UNF M	1500 bar
DUHP-Nozzle	12-28UN M 10-28UN M	2500 bar
DUHP-Nozzle	M7x1 RH M M10x1 RH M	3000 bar
DTLT-Nozzle	1/4" UNF LH F 3/8" - 24 UNF LH F 9/16" - 18 UNF LH F M14x1.5 LH F	3000 bar
DCN-Nozzle	M7x1 F 1/8" BSP F 1/4" BSP F	1500 bar
DCN-Nozzle	9/16" UNF LH F M14x1.5 LH F 3/8" UNF LH F	3000 bar
DTLX-Nozzle	1/4" UNF LH F 3/8" UNF LH F 9/16" UNF LH F	1500 bar
DP-Nozzle	1/16" NPT F 1/8" NPT F 1/4" NPT F	1000 bar
18XX Series Nozzle	1/2" BSP M/F M18x1.5 M M22x1.5 M M24x1.5 M	1500 bar

MADE TO ORDER

DERC Shell Side Blaster SSB

DERC Shell Side Baster SSB

Scan for VIDEO



AUTOMATED SOLUTION FOR EXTERNAL CLEANING OF HEAT EXCHANGER TUBES

The DERC SSB is an automated solution for external cleaning of heat exchangers with high pressure water jets. It makes shell side cleaning simple and safe by placing the operator at a safe distance.

Innovative Design

The DERC SSB consists of two wheeled frames, which can be placed over the heat exchanger, and adjusted in height by means of two manually operated hand wheels. The system comes with two tensioner chains to secure the frames to your tube bundle rollers. The DERC SSB is easy to disassemble in smaller/shorter pieces for easy transportation.

Control Panel

- Speed + Movement tractor left - right
- Speed + Movement bundle rotation
- Speed rotation nozzles
- Air Hoses and Air Preparation Oiler / Filter included

FEATURES

- Air or hydraulic powered
- A-Frames with manual height adjustment
- Chains with tensioner to fix A-Frame to bundle rollers
- DERC Automatic Solutions Rail 4" with gear rack
- DERC RCS-200 swivel
- Control Panel

APPLICATIONS

- General pipe and tube cleaning
- Shell side (heat exchanger) cleaning

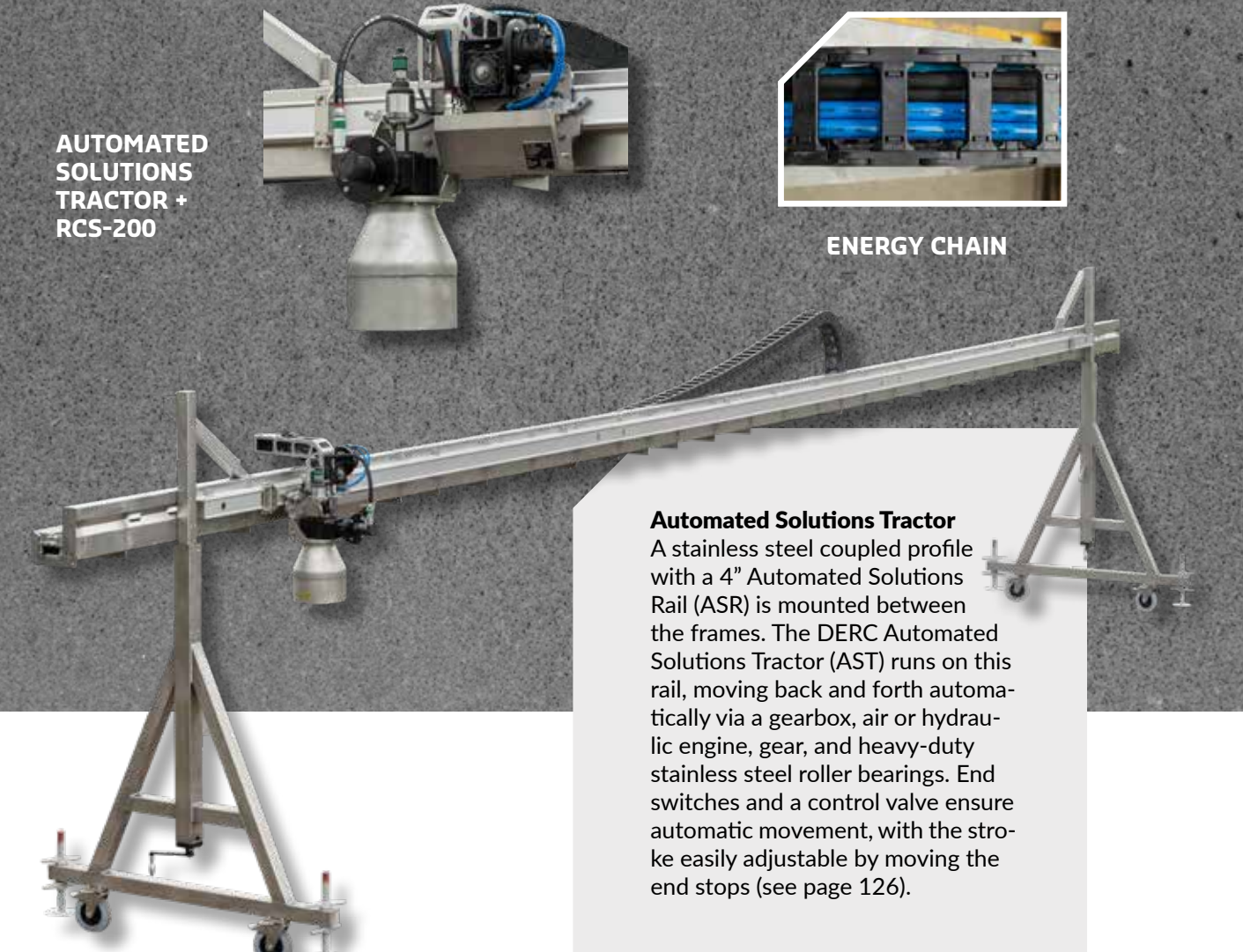

AUTOMATED SOLUTIONS TRACTOR + RCS-200



ENERGY CHAIN

Automated Solutions Tractor

A stainless steel coupled profile with a 4" Automated Solutions Rail (ASR) is mounted between the frames. The DERC Automated Solutions Tractor (AST) runs on this rail, moving back and forth automatically via a gearbox, air or hydraulic engine, gear, and heavy-duty stainless steel roller bearings. End switches and a control valve ensure automatic movement, with the stroke easily adjustable by moving the end stops (see page 126).

SPECIFICATIONS

Total Length	8m / 12 m (other lengths possible)
Max. Tube Bundle Length	7,5 m / 10 m (other lengths possible)
Height Adjustment Frame	1650 - 2600 mm rails
Max. Pressure	1500 bar / 22K
Max. Flow	1000 bar @ 380 lpm / 1500 bar @ 240 lpm
Inlet Connection	M36x2 male / M24x1,5 / 3/4" NPT
Movement Speeds	2 -12 m/min (7 - 40 ft/min)
RCS-200 Rotation Speed	+/- 500 rpm
Nozzle Inserts	2x Type 4 or 2 x Type 226 or 2 x 1/4" NPT

DERC Tube Bundle Rollers

DERC Tube Bundle Rollers

Scan for more info

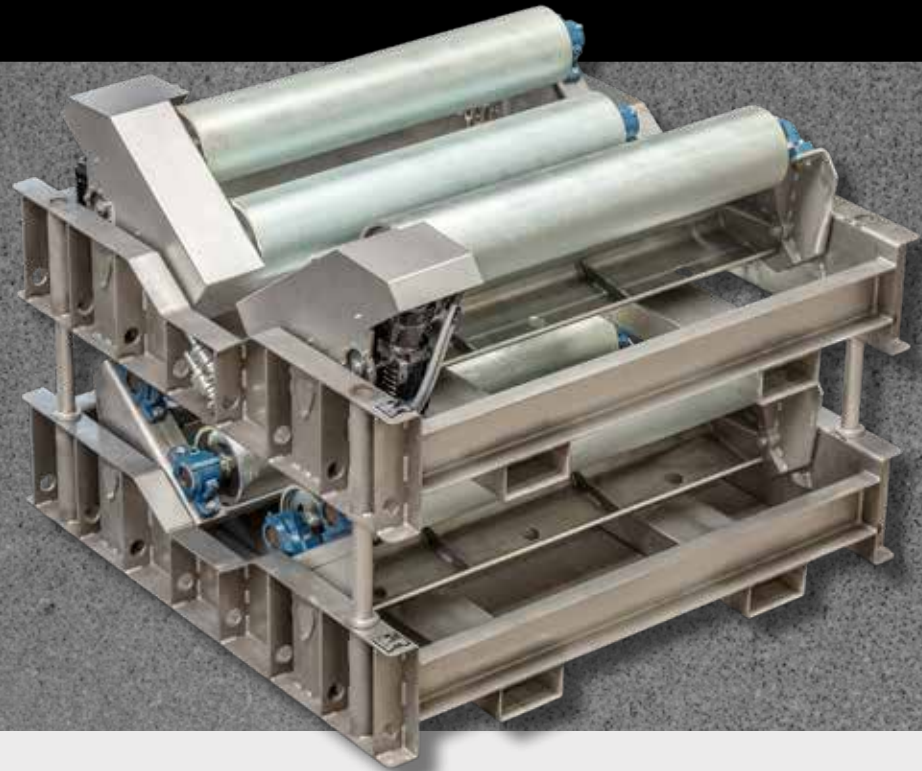

SAFE ROTATION OF PIPE BUNDLES DURING CLEANING

The DERC Tube Bundle Rollers are heavy duty rollers for any bundle up to 25,000 kg. These rollers rotate pipe bundles during cleaning.

Set of Bundle Rollers

The DERC Tube Bundle Rollers are sold in sets of two. Each Bundle Roller contains four rollers for optimal bundle support. One Bundle Roller features driven rollers, while the other Bundle Roller operates without drive. The drive engine can be powered either pneumatically or hydraulically. For easy transport or storage the set can be stacked.

Design

- Stainless steel base frame
- Heavy duty bearings
- Gearbox
- Motor
- Chain tensioner
- Chain guard
- 4 steel zinc plated rollers

FEATURES

- Suitable for a large range of bundle sizes, without adjusting the rollers
- Air or hydraulic driven
- Forklift pockets for easy transport
- Stackable for efficient storage

APPLICATION

- Safe rotation of pipe bundles

SPECIFICATIONS

Max. Load	25,000 kg
Power	Air or hydraulic
Bearing	8 Heavy duty, grease filled bearings per set
Application	Tube bundle minimum diameter 450 mm up to 2000 mm
Weight	Ca. 1000 kg per set (550 + 475)
Dimensions (L x W x H)	1500 x 1500 x 650 mm
Control Panel	Optional



DERC Rotary Coupling Swivel RCS-200

DERC Rotary Coupling Swivel RCS-200

Scan for VIDEO



POWERED ROTATING COUPLING ASSEMBLY

The RCS-200 is an air or hydraulic powered rotating coupling assembly (swivel) with a maximum working pressure of 1500 bar.

Adjustable Speed

Designed for surface cleaning and outside tube bundle cleaning, the RCS-200 features adjustable speed and various nozzle heads and options.

Optional Arms and Heads

The RCS-200 series includes a stainless steel guard protecting the nozzle head and arms. The nozzle head and arms have a 215 mm jet path and are available in 3 versions.

Inlet Connections

The RCS-200 series are standard delivered with the following inlet connections (straight / 90°):

- 3/4" NPT Female
- 3/4" MP Female
- M24 x 1.5 Female Flat

FEATURES

- Various rotations for high jet impact
- Bended nozzle arms with flow stabilizers to produce powerful and effective jets
- Various heads, and customization is possible for a larger range of applications
- Replaceable high quality nozzle tips with maximum jet quality

APPLICATIONS

- External tube bundle cleaning
- Surface cleaning systems and solutions, combined with our automated solution rails and tractors
- Cleaning of floors, conveyors and large surfaces
- Installation on many controlled moveable systems

DERC RCS-200C-HS-A

Max. Pressure	Drive	Rotation Speed	Max. Flow
1000 / 1500 bar	Air	+/- 500 rpm	380 / 240 lpm

DERC RCS-200C-HS-H

Max. Pressure	Drive	Rotation Speed	Max. Flow
1000 / 1500 bar	Hydraulic	+/- 400 rpm	380 / 240 lpm

OPTIONAL ARMS AND HEADS

Arm Type	Nozzle Type	Max. Pressure	
RCS-230B-M20-T4	Type 04 nozzles	1500 bar	Complete with flow stabilizers and nozzle caps
RCS-230B-M20-T226	Type 226 nozzles	1000 bar	Complete with flow stabilizers and nozzle caps
RCS-230B-14NF	DI 14 nozzles	1000 bar	With integrated flow inducer

DERC Rigid Lance Cleaner RLC

DERC Rigid Lance Cleaner RLC

Scan for more info



SAFE AND FAST CLEANING OF HEAT EXCHANGER TUBES

The DERC Rigid Lance Cleaning System is a modular rigid lancing system to clean heat exchanger tube bundles. It is perfect for safe and fast removal of hard plugs, scaling and general cleaning of heat exchangers. The RLC is easy to adapt to any length and suitable for a maximum working pressure of 3000 bar.

Automated Solutions Rail

The basis of the RLC system is an aluminum rail with gear rack on which a modular rotating lancing carriage drives the lances in and out the heat exchanger tubes.



FEATURES

- Control panel
- DERC Automatic Solutions Rail 4" with gear rack
- DERC Modular Lance Rotating Drive Unit
- 1, 2, 3 or 5 lances
- DERC X-Y Positioner
- Air powered (hydraulic on request)
- A-Frame for rear support (horizontal appl.)

APPLICATION

- Heat exchanger cleaning

X-Y Positioner

For positioning the lances in front of the heat exchanger the RLC system comes with an X-Y Positioner. This X-Y Positioner can be used for horizontal or vertical applications of the RLC. For horizontal applications it consists of a removable wheel kit, support stands / legs and scaffolding guides. For vertical applications the X-Y positioner is mounted to the tube bundle.

Rear Support / A-Frame

For stability the RLC is equipped with a rear support. For horizontal applications this is an A-Frame with a movable support chain. For vertical applications a custom solution is needed depending on the length of the aluminum rail.



DERC Rigid Lance Cleaner RLC



Modular Lance Rotation Drive Unit
On the lance carriage you will find our Modular Lance Rotation Drive Unit. This modular block can be converted to rotate 1, 2, 3 or 5 high pressure lances in any pressure range.



DERC Rigid Lance Cleaner RLC

Scan for more info



Control Panel

For controlling all the functions of the RLC system the machine comes with a control panel, placing the operator out of the line of fire.

Power

The RLC system is standard fully air powered, however on request we can offer a hydraulic version of the system.

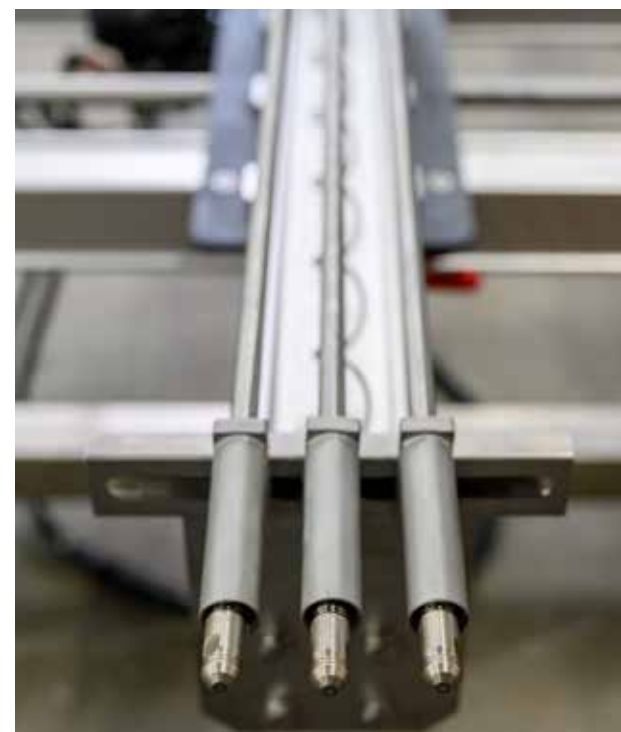

Nozzles and Lances

Based on your requirements, DERC Salotech offers a full range of nozzle and lance configurations for the RLC (see page 20 and 128).

DERC Blast Container

DERC Blast Container

Scan for more info

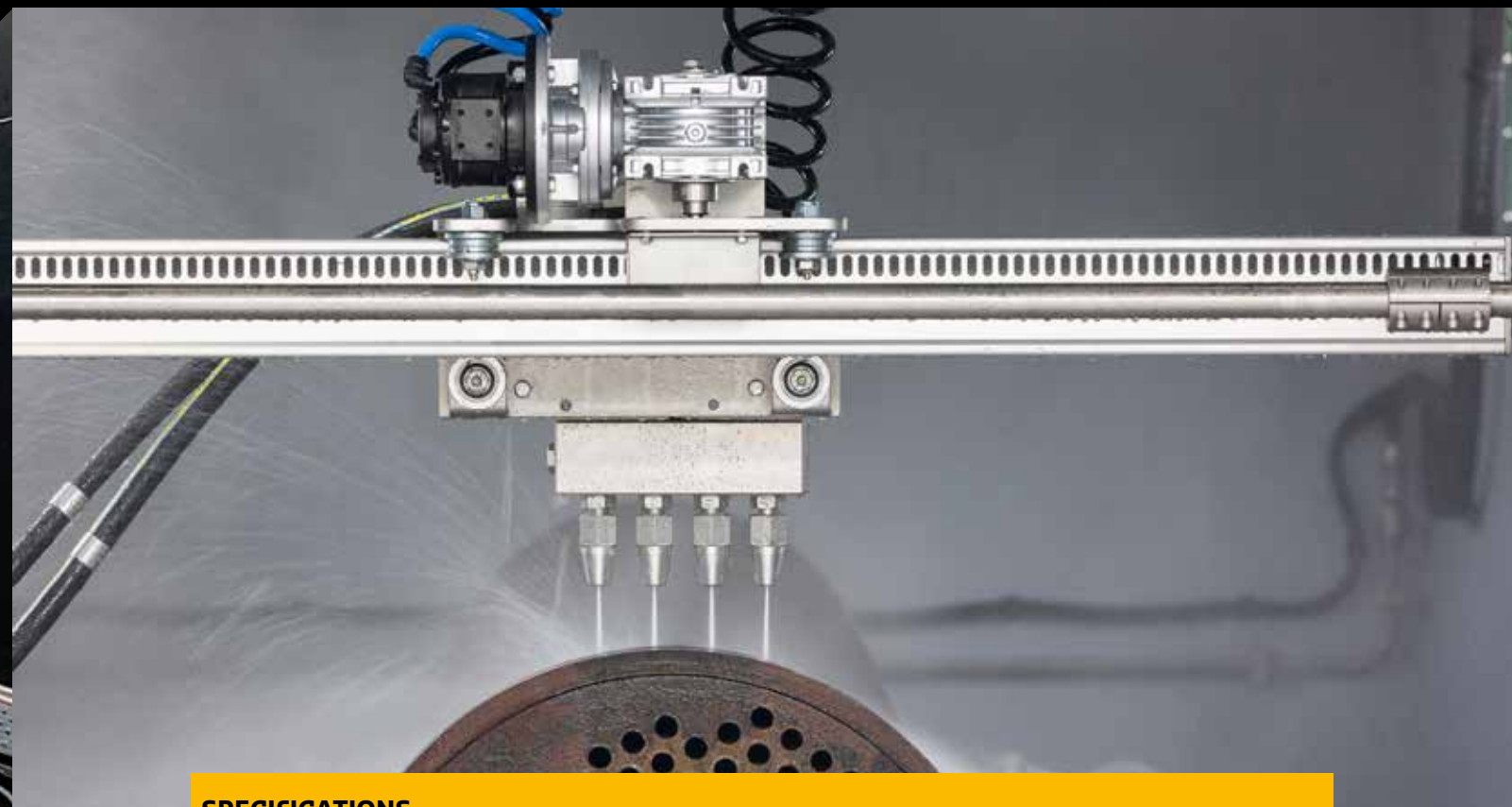

THE MOBILE SOLUTION FOR SAFE AND CLOSED TUBE BUNDLE CLEANING

The DERC Blast Container is a (semi) automatic solution for closed high pressure water jetting of tube bundles. It is suitable for tube bundles with a diameter of 450-1600 mm and a maximum length of 6000 mm.

Mobile and Emission Free

The Blast Container is a bundle blaster which is built into a container. This makes the bundle blaster easy to transport and possible to use on your desired location. Waste water and debris is collected, so there is no pollution of the direct environment.

Internal and External Cleaning

The Blast Container is able to clean both the inside and the outside of the tube bundles or other parts. For internal cleaning there is an adapter plate to connect your flex lance machine.

Bundle Rollers

The DERC Blast Container comes with pneumatic driven tube bundle rollers with a maximum capacity of 25 ton.

FEATURES

- Mobile, easy to transport
- Full pneumatic or electric pneumatic controls
- Full pneumatic bundle rollers
- Emission free
- 4-jets manifold with high speed nozzles
- Other jet manifolds available
- Adapter plate for flex lance machine for internal cleaning

APPLICATION

- Closed external and internal cleaning of tube bundles

SPECIFICATIONS

Tube Bundle Range	450-1400 mm
Max. Tube Bundle Length	6000 mm
Max. Pressure	1000 bar
Max. Flow	200 lpm
Manifold	4-jets with high speed nozzles
Nozzles	Type 04 or 226
Drive	Air powered
Bundle Rollers	Air powered max. 25 ton
Control	Air or electric pneumatic



DERC R-Tube

DERC R-Tube

Scan for more info



INNOVATIVE SOLUTION FOR CLEANING OUTSIDE OF PIPES

The R-Tube is an automated solution for efficient surface preparation and cleaning of the outside diameter of pipes.

Design

It consists of a carrier, which travels the length of the pipe and 2 cleaning heads equipped with 2 Masterjets with custom-made suction manifolds to secure no leakage.

The cleaning head rotates (180 degrees) around the pipe to ensure no surface is left untouched.

Flexible Operation

The R-Tube is designed as a (semi)open concept which means that both carrier and cleaning heads don't surround the entire pipe. This allows the machine to move past obstacles such as pipe supports, crane lugs and possibly branching pipes. Mounting is easy and doesn't require any special tools.

FEATURES

- Compact design
- Easy mounting
- Adjustable to different diameters (6" up to 32", other sizes possible on request)
- Up to 3000 bar @ 18 l/min
- Open construction
- MagTrack remote controls
- Travel speed: 0 - 3 m/min

APPLICATIONS

- Automated surface preparation and cleaning of the outside diameters of pipes

Various Sizes

This innovative cleaning tool comes in 2 models making it capable of cleaning diameters from 6" up to 32". Other sizes are possible on request (see next pages for a 60" XXL version).

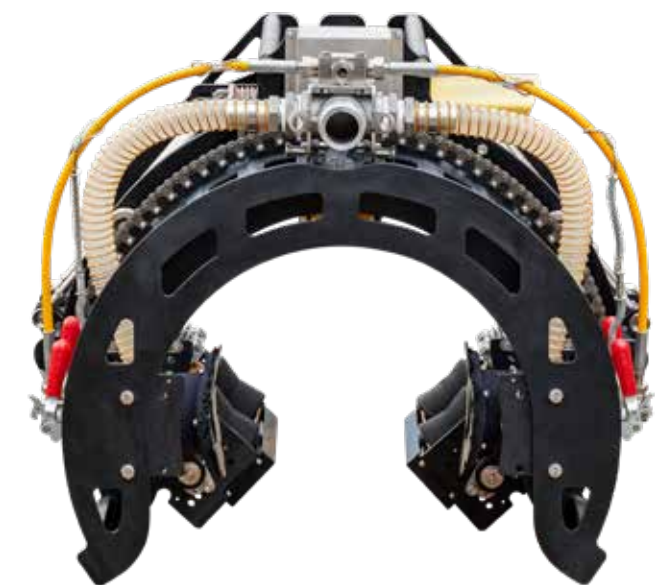

DERC R-Tube

DERC R-Tube

Scan for VIDEO



R-Tube XXL

Designed for ultra-high-pressure (UHP) coating removal, this R-Tube XXL efficiently removes hazardous lead-based paint from a 2 km, 60" diameter penstock pipe. Built for pressures up to 3000 bar with vacuum recovery, it ensures a fast, safe, and environmentally friendly process.

DERC Rotating Pipe Cleaner RPC

DERC Rotating Pipe Cleaner RPC

Scan for more info

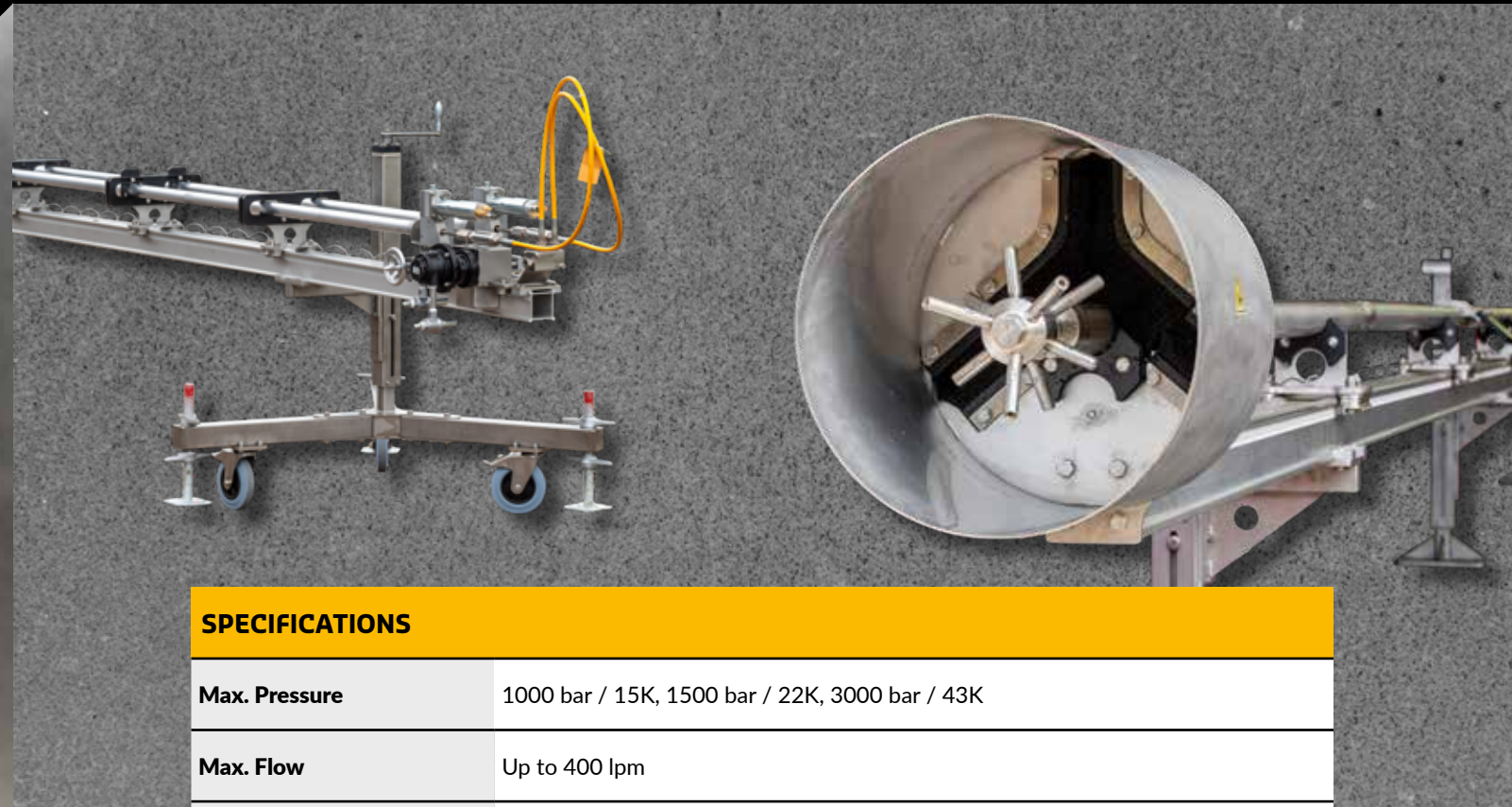

SAFE AND EASY CLEANING OF LARGE ID (DRILL) PIPES

The DERC Salotech Pipe Cleaner is the tool for cleaning (drill) pipes with all kind of deposits. Hard cement, drill mud or even NORM cleaning is possible with this tool.

The DERC RPC has a rugged modular design, and is easy to built up and disassemble for transport. The jack stands are height adjustable and come with wheels and jacks.

FEATURES

- Rugged modular design
- Available in various pressure ranges up to 3000 Bar (43K)
- Rotation speed/feed independent adjustable
- Configurable in length
- Unique UHP lance construction with support casing
- Rugged Guide blocks with 4 roller bearings
- Configurable centralizers and nozzle carriers

APPLICATIONS

- Cleaning (drill) pipes
- Remove hard cement, drill mud
- NORM cleaning



SPECIFICATIONS

Max. Pressure	1000 bar / 15K, 1500 bar / 22K, 3000 bar / 43K
Max. Flow	Up to 400 lpm
Length	Configurable
Jack Stands	Stainless Steel; Standard 2x pieces height adjustable complete with jacks and wheels; Longer length RPC needs more jack stands
Guide Blocks	Stainless Steel 4 roller bearings heavy duty
HP Lance(s)	Configurable to pressure, single or dual
Control Panel	Stainless steel; Complete with oiler, filter and air hoses; Functions: lance feed in/out, rotation, both speed regulated independently
Nozzles and Centralizers	Configurable to the working pressure and pipe diameter



DERC Speed Regulated Line Cleaner SLC

DERC Speed Regulated Line Cleaner SLC

Scan for more info

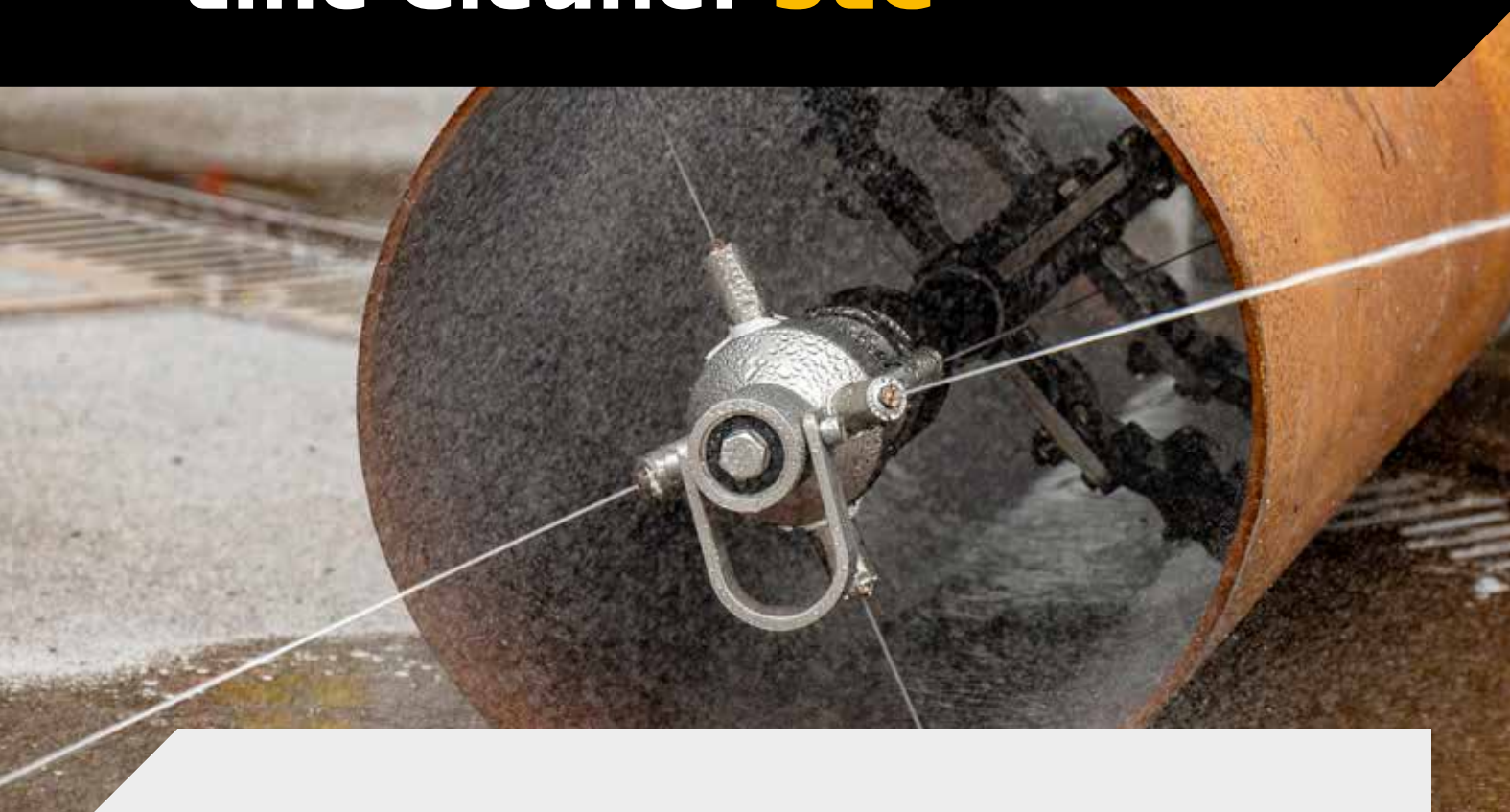

VERSATILE MODULAR PIPE CLEANING TOOL

The rotation speed of this modular pipe cleaning tool can easily be adjusted “manually” for the required cleaning job. Slow speeds for plugged pipes with hard residues, and fast speeds for polishing the inner walls of the pipes.

Cleaning Heads

To suit the requirements of every cleaning job the SLC has a variety of head choices available to which you can connect a pulling ring, customized ports and have multiple jetting options. The SLC heads are based on pressure, flow and type of cleaning work.

Extension Lances

Certain head options require extension nipples. See our extension lances for the possibilities.

FEATURES

- Up to 1500 bar
- Manual speed adjustment
- Choose the right SLC head for the job
- Optional pulling ring
- Optional extension lances
- Rugged stainless steel construction

APPLICATIONS

- Cleaning plugged pipes with hard residues
- Polishing inner walls of pipes

SLC OPTIONS

	SLC-1000	SLC-1500
Inlet Connection	3/4"NPT F	M24 x 1.5 Flat F 3/4" or 14 NPS F (3/4 MP)
Shaft Connection	3/4"NPT M	M24 x 1.5 Flat M
Max. Pressure	1000 bar	1500 bar
Diameter	75 mm	75 mm
Length	155 mm	175 mm
Max. Flow	380 lpm	380 lpm
Part No.	SLC-1000-34NF.34NM	SLC-1500-24FV.24MR, SLC-1500-M12F.24MR

Accessories

The DERC Salotech centralizers allow the SLC to work seamlessly with our high pressure extension arms, placing the effective water jets closer to the wall of the pipe. In addition the jetting configurations can easily be optimized with our high quality DERC Salotech inserts, to provide either more pulling power or more unplugging power.

DERC Speed Regulated Line Cleaner SLC

DERC Speed Regulated Line Cleaner SLC

Scan for more info



SLC HEAD OPTIONS						
	SLC-56-12NF	SLC-56-14NF	SLC-57-14NF	SLC-66-14NF	SLC-66-34UF	SLC-67-14NF
Off Set	3, 5, 9, 15	3, 5, 9, 15	3, 5, 9, 15	3, 5, 9, 12, 15	5, 9, 12, 15	3, 5, 9, 15
Max. Pressure	1000 bar	1000 bar	1000 bar	1500 bar	1500 bar	1500 bar
Connection	6x 1/2" NPT	6x 1/4" NPT	7x 1/4" NPT	6x 1/4" NPT	6x 3/4" UNF	7x 1/4" NPT
Jet Angle	2x 45°, 2x 90° 2x 135°	2x 45°, 2x 90° 2x 135°	1x 15°, 2x 45° 2x 90°, 2x 135°	2x 45°, 2x 90° 2x 135°	2x 45°, 2x 90° 2x 135°	2x 15°, 2x 45° 2x 90°, 2x 135°
Extension Lance	SLC-56-EXT-xxx	-	-	-	SLC-66-EXT-xxx	-
Pulling Ring	SLC-90	SLC-90	-	SLC-90	SLC-90	-



SLC EXTENSION LANCES		
SLC-1000	TOTAL WIDTH 90 GR	TOTAL WIDTH 45 GR
SLC-56-EXT-050	190	146
SLC-56-EXT-075	240	181
SLC-56-EXT-100	290	217
SLC-56-EXT-150	390	287
SLC-56-EXT-200	490	358
SLC-56-EXT-250	590	428
SLC-56-EXT-300	690	499
SLC-56-EXT-350	790	569
SLC-56-EXT-400	890	640
SLC-1500	TOTAL WIDTH 90 GR	TOTAL WIDTH 45 GR
SLC-66-EXT-050	182	140
SLC-66-EXT-075	232	175
SLC-66-EXT-100	282	210
SLC-66-EXT-150	382	281
SLC-66-EXT-200	482	351
SLC-66-EXT-250	582	422
SLC-66-EXT-300	682	492
SLC-66-EXT-350	782	563



CALL US +31 186 - 62 14 84

DERC RotoCar Cleaning System

DERC RotoCar Cleaning System

Scan for VIDEO



CLEANING COMPLEX, BENDED AND LONG PIPE LINES WITH HIGH OPERATOR SAFETY

The DERC RotoCar Cleaning System is developed to remove difficult scales and incrustations on the inside of tubes or pipelines in a very fast and highly efficient way, with extremely high safety standards for the operator. We offer a 1500 and 3000 bar version.

How Does It Work?

The DERC RotoCar unit rotates a rubber high pressure hose. The rotation is done by an air motor. The "feed mechanism" will feed or pull the hose automatically in or out of the tube. The speed of the high pressure hose is manually adjustable for optimal cleaning results with different applications.

Rotate, Push & Pull

The RotoCar rotates a high pressure hose by means of a swivel, gearbox and air engine. The rotating hose runs through the feeder unit which pushes or pulls the high pressure hose in or out of the tube. The RotoCar is equipped with a slip coupling which ensures that the high pressure hose can only rotate while it is on pressure.

FEATURES

- 1500 or 3000 bar version
- Fast and highly efficient cleaning of pipes
- High operator safety
- Automatic feed and pull of hose
- Speed of hose feed and pull adjustable

APPLICATIONS

- Cleaning inside of tubes or pipelines
- Cleaning the most complex, bended and longest pipe line constructions
- Also suitable for large diameter pipes
- Remove difficult scales and incrustations

SPECIFICATIONS

Max. Pressure	1500 or 3000 bar
Max. Flow	380 lpm (1500 bar) or 140 lpm (3000 bar)
Hose Connection 1500 bar	M24 x 1.5 DKOS male, M36 x 2 DKOS male (inlet and outlet)
Hose Connection 3000 bar	9/16" HP
Rotating Speed	Adjustable from 20 till 300 rpm
Length Protecting Hose	3 m (10 ft)
Weight	Approximate 65 kg

Adjustable Speed

The speed of the high pressure hose is manually adjustable for optimal cleaning result with different applications. To insert the hose in the middle of the tube an adjustable clamping device is mounted on the front of the tube or pipe. To prevent damage to the rotating hose, there is a 2" or 3" stainless steel flexible tube mounted between the clamp device and the feed mechanism.

RotoCar Nozzles

The rotating hose in combination with our special nozzle range ensures a perfect cleaning effect and is suitable for cleaning the most complex, bended and longest pipe line constructions. We offer RotoCar nozzles for the 1500 and 3000 bar versions.



CALL US +31 186 - 62 14 84

DERC Speed Regulated Pipe Cleaner SPC

DERC Speed Regulated Pipe Cleaner SPC

Scan for more info



CLEANING INDUSTRIAL PIPES WITH MULTIPLE ELBOWS

The DERC Speed Regulated Pipe Cleaner (SPC) is developed for high pressure water jet cleaning of bended pipes. The nozzles of this industrial pipe cleaner are water driven and suitable for working pressures up to 1500 Bar.

Rotation Speed Control

All SPC nozzles are equipped with an easy adjustable rotation speed control and are provided with a hardened protection ring. The compact, stainless steel design ensures that this nozzle can unplug, polish or run longer lines without any problem.

Three Sizes: SPC-S, SPC-M and SPC-L

The rotating speed can be adjusted, depending on the level of deposit. DERC SPC is available in three sizes: SPC-S, SPC-M and SPC-L. The SPC-L is designed and constructed for waterblast cleaning of industrial pipes as small as 6" with elbows and up. The SPC-M is for cleaning 4" pipes. And the SPC-S is made for the same work in pipes as small as 2" with elbows.

FEATURES

- 2" - 4" - 6" model
- Compact and short design
- Adjustable rotation speed by an adjusting nut
- Long life of high pressure seals
- Max. working pressure 1500 Bar/ 22K
- One type of oil
- Optional storage case

APPLICATIONS

- Cleaning pipes with multiple elbows

SPC Storage Case

To securely transport your SPC we provide an (optional) storage case.



SPC-S		
Max. Pressure	1000 bar / 15K	1500 bar / 22K
Flow	30 - 50 l/min / 8-13gpm	30 - 50 l/min / 8-13gpm
Inlet Connection	1/4" NPT F	1/4" BSP, 3/8" UNF LH 3/8" UNF RH, 9/16" UNF LH/RHF
Rotation Speed	100 - 300 RPM (adjustable)	100 - 300 RPM (adjustable)
Pipe Sizes	2" - 4" (DN50 - DN100)	2" - 4" (DN50 - DN100)
Inserts	7 x M4 (046.xxx)	7 x M4 (046.xxx)
Diameter	Ø 35 mm	Ø 35 mm

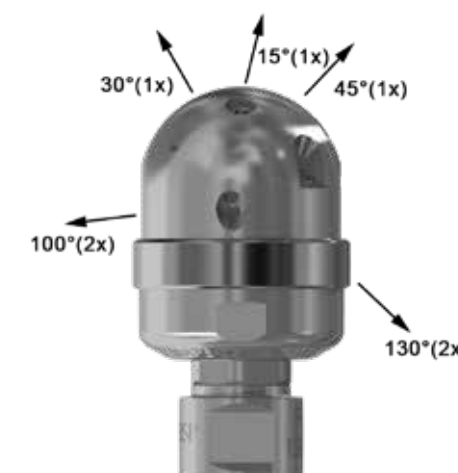

Centralizer

The DERC SPC Centralizer makes it possible to centre the DERC SPC-M and SPC-L. This is protecting the rotating nozzle and for achieving the best cleaning result.

SPC Toolkit

The DERC SPC comes with a special tool for manual setting of the braking / speed adjustment.

DERC Speed Regulated Pipe Cleaner SPC

DERC Speed Regulated Pipe Cleaner SPC

Scan for more info



SPC-M		
Max. Pressure	1000 bar / 15K	1500 bar / 22K
Flow	50 - 115 l/min / 13-30gpm	50 -100 l/min / 13-26gpm
Inlet Connection	3/8" NPT F	M24 x 1.5 DKOS, 3/4" type M, 3/4" 16 UNF M
Rotation Speed	50-300 RPM (adjustable)	50-300 RPM (adjustable)
Pipe Sizes	4" - 8" (DN100 - DN200)	4" - 8" (DN100 - DN200)
Inserts	5 x 1/8" NPT (DI 18.xxx)	5 x 1/8" NPT (DI 18.xxx)
Diameter	Ø 69 mm	Ø 69 mm

SPC-L		
Max. Pressure	1000 bar / 15K	1500 bar / 22K
Flow	55 - 210 l/min / 14.5- 55.5gpm	50 -170 l/min / 13 - 45gpm
Inlet Connection	1/2" NPT F	M24 x 1.5 DKOS, M36 x 2 DKOS 9/16" MPF (13/16")
Rotation Speed	50-300 RPM (adjustable)	50-300 RPM (adjustable)
Pipe Sizes	6" - 12" (DN150 - DN300)	6" - 12" (DN150 - DN300)
Inserts	5 x 1/4" NPT (DSI 14.xxx)	5 x 1/4" NPT (DSI 14.xxx)
Diameter	Ø 95 mm	Ø 95 mm



CALL US +31 186 - 62 14 84

DERC Speed Regulated Pipe Cleaner SPC-UH



CLEANING PIPES WITH MULTIPLE ELBOWS UP TO 3000 BAR / 43K

The SPC-UH nozzles have a working pressure up to 3000 bar and are provided with a hardened protection ring.

Modular Design

The high pressure swivel with the adjustable break and the nozzle head are modular, in two parts. This design enables SPC-UH nozzle assemblies with different nozzle heads (R size) to suit your high pressure pump capacity.

Adjustable rotation speed

The rotation speed can easily be adjusted by hand (spanner) to adjust the SPC-UH tool for each application. The SPC-UH is designed and constructed for waterblast cleaning of pipes as small as 4" with elbows.

Centralizer

The DERC SPC Centralizer makes it possible to centre the DERC SPC-UH, thus protecting the rotating nozzle and achieve the best cleaning result.

FEATURES

- Heavy duty stainless steel construction
- Short and robust design
- Adjustable rotation speed by an adjusting nut
- Unique versatile tool due to modular design
- Low maintenance
- Long life of high pressure seals

APPLICATION

- UHP Cleaning of bended pipes as small as 4" with multiple elbows

DERC Speed Regulated Pipe Cleaner SPC-UH

Scan for more info



Connections

The DERC SPC-UH is available with 3/4" UNF F (3/8" HP, H6) and 7/8" UNF M connection. For both these types we offer thermoplastic hoses of SpirStar to keep the complete assembly as short as possible.

3/4" UNF F

Part No.	SPC-UH-H6F-R4	SPC-UH-H6F-R6	SPC-UH-H6F-R8.5
Max. Pressure	3000 bar	3000 bar	3000 bar
Pressure 2500 bar	35/55 l/min	25-35 l/min	17-25 l/min
Pressure 2800 bar	35/50 l/min	25-35 l/min	17-25 l/min
Pressure 3000 bar	35/50 l/min	25-35 l/min	17-25 l/min
Inlet Connection	3/4" UNF F	3/4" UNF F	3/4" UNF F
Rotation Speed	100-500 rpm	100-500 rpm	100-500 rpm
Inserts	5 x 965.xxx	5 x 965.xxx	5 x 965.xxx
Length	114 mm	114 mm	114 mm
Diameter	70 mm	70 mm	70 mm
Weight	1,65 kg	1,65 kg	1,65 kg
Max. Temp. Med.	80°C	80°C	80°C

7/8" UNF M

Part No.	SPC-UH-78UHM-R4	SPC-UH-78UHM-R6	SPC-UH-78UHM-R8.5
Max. Pressure	3000 bar	3000 bar	3000 bar
Pressure 2500 bar	35-55 l/min	25-35 l/min	17-25 l/min
Pressure 2800 bar	35-50 l/min	25-35 l/min	17-25 l/min
Pressure 3000 bar	35-50 l/min	25-35 l/min	17-25 l/min
Inlet Connection	7/8" UNF M	7/8" UNF M	7/8" UNF M
Rotation Speed	100-500 rpm	100-500 rpm	100-500 rpm
Inserts	5 x 965.xxx	5 x 965.xxx	5 x 965.xxx
Length	133 mm	133 mm	133 mm
Diameter	70 mm	70 mm	70 mm
Weight	1,75 kg	1,75 kg	1,75 kg
Max. Temp. Med.	80°C	80°C	80°C

CALL US +31 186 - 62 14 84

DERC Centralizers CENT 8W / SPC / 6-8-10

DERC Centralizers CENT 8W / SPC / 6-8-10

Scan for more info



CENT-8W-S

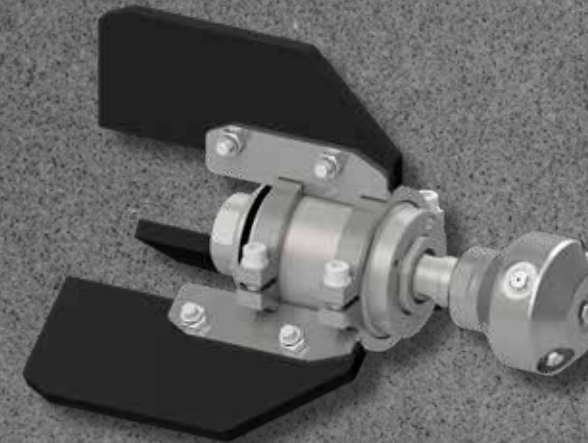

CENT 6-8-10

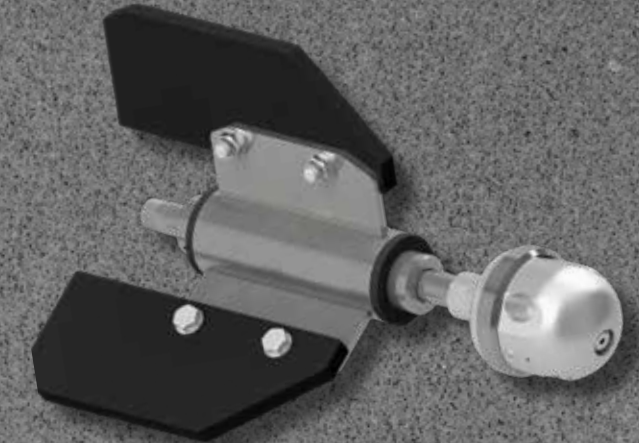

CENT SPC

CENTRALIZING YOUR NOZZLE IN PIPES

DERC Salotech designed centralizers to centre the rotating nozzle within the pipe, thus protecting the nozzle and the pipe walls and ensuring the best cleaning result.

CENT 6-8-10 / CENT 8W

Two models of centralizers are available for the SLC (see page 38):

- CENT 6-8-10
- CENT 8W

These centralizers allow the tools to work in bigger diameter pipe lines, drums, shells or columns.

The centralizers assure a good, consistent cleaning, correct jet distance to the pipe wall and guide the SLC through any bends or ducts.

The CENT 8W can also be used with any other tool (besides the SLC) where a centralizer is needed.

FEATURES

- Heavy duty stainless steel construction
- Easy to mount
- Protecting nozzles and pipe walls
- Optimize cleaning results

APPLICATION

- Centralizing SPC / SLC nozzles in pipes

CENT SPC

To centre the SPC (see page 44) within small lines, we offer a short stainless steel centralizer. This complete kit for three different diameters (6-8-10") is easy to adjust to another diameter by switching out the plastic fins.

CENT 6-8-10

Model	Range Inside Pipe Diameter	Rotating Nozzle
CENT 6-8-10	6" / 8" / 10" (DN150 - DN250)	SLC

CENT 8W

Model	Range Inside Pipe Diameter	Rotating Nozzle
CENT-8W-XL	35" - 56" (DN885 - DN1438)	SLC
CENT-8W-L	26" - 40" (DN660 - DN1000)	SLC
CENT-8W-M	22" - 30" (DN550 - DN750)	SLC
CENT-8W-S	12" - 20" (DN300 - DN500)	SLC

CENT SPC

Model	Connection	Max. Pressure	Rotating Nozzle
CENT-SPC-38NM	3/8" NPT M	1000 bar	SPC-M
CENT-SPC-24M	M24x1.5 M	1500 bar	SPC-M / SPC-L
CENT-SPC-12NM	1/2" NPT M	1000 bar	SPC-L
CENT-SPC-36M	M36x2 M	1500 bar	SPC-L
CENT-SPC-H9LM	9/16" HP	3000 bar	SPC-UH

DERC Rotary Coupling Swivel RCS-UHS

DERC Rotary Coupling Swivel RCS-UHS

Scan for
more info



RCS-UHS OPTIONS

Inlet Connection	Shaft Connection	Diameter	Length	Max. Pressure	Max. Flow	Part No.
M30 X 2 F	M14 x 1.5 LH M	45 mm	165 mm	3000 bar	75 lpm	RCS-UHS-M14
1 1/8" - 12 UNF F	9/16"- 18 UNF LH M	45 mm	165 mm	3000 bar	75 lpm	RCS-UHS-916HP
1 1/8" - 12 UNF F 90°	9/16"- 18 UNF LH M	45 mm	180 mm	3000 bar	75 lpm	RCS-UHS-916HP 90°
1 1/8" - 12 UNF F	9/16"- 18 UNF LH M (long)	45 mm	200 mm	3000 bar	75 lpm	RCS-UHS-L-916HP

MAINTENANCE KITS

Description	Part No.
Minor kit	RCS-UHS-100
Major kit	RCS-UHS-300
Tool kit	RCS-44-500



RUGGED DESIGN, EASY TO MAINTAIN

DERC RCS Ultra High pressure Swivels are designed to transport high pressure water from a stationary line to a rotating or twisting assembly.

Rugged Design

Heavy duty bearings, low torque rotation and the rugged design make the RCS-UHS suitable for many applications.



FEATURES

- Unique, improved and easy to maintain
- Available with various connections
- Heavy duty, stainless steel construction
- Low static torque for easy rotation
- 0° or 90° inlet connection
- Up to 2000 RPM
- Metric and UNF connections

APPLICATIONS

- Hose reels
- Automated systems and solutions
- Lance cleaning systems

CALL US +31 186 - 62 14 84

DERC Rotary Coupling Swivel RCS-UHS Mini

DERC Rotary Coupling Swivel RCS-UHS Mini

Scan for more info



RUGGED DESIGN, EASY TO MAINTAIN

DERC RCS Ultra High pressure Swivels are designed to transport high pressure water from a stationary line to a rotating or twisting assembly.

Up To 3000 Bar

The RCS-UHS Mini is specially designed for water jetting guns with maximum pressure up to 3000 bar.

FEATURES

- Heavy duty stainless steel construction
- Up to 3000 bar working pressure
- Up to 2000 RPM
- Low maintenance
- Metric and UNF connections
- Lightweight and compact
- Low torque, easy to rotate

APPLICATIONS

- High pressure guns

RCS-UHS MINI OPTIONS

Inlet Connection	Shaft Connection	Diameter	Length	Max. Pressure	Max. Flow	Part No.
M26 x 1.5 F	M14 x 1.5 LH M	35 mm	125 mm	3000 bar	25 lpm	RCS-UHS-MINI.26F.M14ML
M26 x 1.5 F	9/16" - 18 UNF LH M	35 mm	135 mm	3000 bar	25 lpm	RCS-UHS-MINI.26F.916UML
M26 x 1.5 F 90°	M14 x 1.5 LH M	35 mm	138 mm	3000 bar	25 lpm	RCS-UHS-MINI.26F.M14ML-90
M26 x 1.5 F 90°	9/16" - 18 UNF LH M	35 mm	148 mm	3000 bar	25 lpm	RCS-UHS-MINI.26F.916UML-90

MAINTENANCE KITS

Description	Part No.
Minor kit	RCS-UHS-MINI-100
Major kit	RCS-UHS-MINI-300
Tool kit	RCS-44-500



CALL US +31 186 - 62 14 84

DERC Rotary Coupling Swivel RCS Mini

DERC Rotary Coupling Swivel RCS Mini

Scan for more info



RCS MINI OPTIONS

Inlet Connection	Shaft Connection	Diameter	Length	Max. Pressure	Max. Flow	Part No.
1/2" NPT F	1/2" NPT M	35 mm	115 mm	1000 bar	80 lpm	RCS-MINI-12NMF
M24 x 1.5 DKOS M	1/2" BSP MV	35 mm	125 mm	1500 bar	80 lpm	RCS-MINI-24M-12MV
M24 x 1.5 DKOS M	M22 x 1.5 MV	35 mm	125 mm	1500 bar	80 lpm	RCS-MINI-24M-22MV
13/16"-16 UN F	13/16"-16 UNF M	35 mm	120 mm	1500 bar	80 lpm	RCS-MINI-916MP
M24 x 1,5 DKOS M	1/2" NPT M	35 mm	125 mm	1000 bar	80 lpm	RCS-MINI-24M.12NM
M24 x 1,5 DKOS M	1/2" NPT F	35 mm	135 mm	1000 bar	80 lpm	RCS-MINI-24M.12NF

MAINTENANCE KITS

Description	Part No.
Minor kit	RCS-MINI-100
Major kit	RCS-MINI-300
Tool kit	RCS-44-500

THE COMPACT SWIVEL FOR ANY GUN UP TO 1500 BAR

The DERC RCS-mini swivels are a complete range of swivels specially designed for jetting guns up to 1500 bar.



FEATURES

- Available with various connections
- Compact and lightweight
- Low torque, easy to rotate and low maintenance
- Small in diameter, easy to fit in combination with a hose sleeve
- Up to 600 RPM
- NPT, metric and UNF connections

APPLICATIONS

- Easy hose handling
- Prevents hose twisting
- Fits any gun



DERC Rotary Coupling Swivel RCS-44

DERC Rotary Coupling Swivel RCS-44

Scan for more info



RCS-44 OPTIONS

Inlet Connection	Shaft Connection	Diameter	Length	Max. Pressure	Max. Flow	Part No.
1/2" NPT F	1/4" NPT M	44 mm	115 mm	1000 bar	140 lpm	RCS-44-12NF.14NM
13/16" UNF F	9/16" UNF LH M	44 mm	155 mm	1500 bar	100 lpm	RCS-44-916MP
13/16" UNF F 90°	9/16" UNF LH M	44 mm	150 mm	1500 bar	100 lpm	RCS-44-916MP-90°

MAINTENANCE KITS

Description	Part No.
Major kit RCS-44 1500 bar	RCS-44-1500-300
Minor kit RCS-44 1500 bar	RCS-44-1500-100
Major kit RCS-44 1000 bar	RCS-44-300
Minor kit RCS-44 1000 bar	RCS-44-100
Tool kit RCS-44	RCS-44-500



LOW MAINTENANCE, EASY TO MAINTAIN

DERC RCS-44 swivels are designed to transport high pressure water from a stationary line to a rotating or twisting assembly. They feature replaceable seals, heavy duty ball bearings, a stainless steel construction and a low static torque for easy rotation.

Low Maintenance

The DERC RCS-44 swivels are low maintenance due to life lubricated bearings, no need to add grease. They are installed as standard equipment on our lancing machines and are available with either 0° or 90° inlets.



FEATURES

- Replaceable seals
- Lifetime lubricated ball bearings
- Low static torque for easy rotation
- Stainless steel construction
- 0° or 90° inlet connection
- Common metric wrench sizes
- NPT, metric and UNF threadings available
- Up to 600 RPM

APPLICATIONS

- Lancing machines
- Hose reels
- Rotating equipment

CALL US +31 186 - 62 14 84

DERC Rotary Coupling Swivel RCS-75

DERC Rotary Coupling Swivel RCS-75

Scan for more info



RUGGED DESIGN, EASY TO MAINTAIN

DERC RCS-75 swivels are designed to transport high pressure water from a stationary line to a rotating or twisting assembly. Heavy duty ball bearings, low torque rotation and the rugged design make the DERC RCS-75 suitable for many applications.

The swivels are low maintenance due to life lubricated bearings, no need to add grease. Available with either 0° or 90° inlets. Standard speed is up to 600 RPM. We also offer a high speed version with a speed up to 2000 RPM.



FEATURES

- Unique, improved and easy to maintain seal
- Lifetime lubricated bearings
- Multiple inlet options available
- Heavy duty stainless steel construction
- 0° or 90° inlet connection
- Common metric wrench sizes
- Available in metric, UNF and NPT threading
- Up to 600 RPM
- High Speed version up to 2000 RPM

APPLICATIONS

- Hose reels
- Automated systems and solutions
- Prevention of hose twist in large lines



RCS-75 OPTIONS

Inlet Connection	Shaft Connection	Diameter	Length	Max. Pressure	Max. Flow	Part No.
M24 x 1.5 F	M24 x 1.5 M	75 mm	150 mm	1500 bar	400 lpm	RCS-75-24FV.24MV
M24 x 1.5 F 90°	M24 x 1.5 M	75 mm	150 mm	1500 bar	400 lpm	RCS-75-24FV.24MV 90°
3/4" NPT F	3/4" NPT M	75 mm	150 mm	1000 bar	400 lpm	RCS-75-34NF.34NM
3/4" NPT F	M24 x 1.5 M	75 mm	150 mm	1000 bar	400 lpm	RCS-75-34NF.24MV
3/4" NPT F 90°	3/4" NPT M	75 mm	150 mm	1000 bar	400 lpm	RCS-75-34NF.34NM 90°
M24 x 1.5 M	M24 x 1.5 M	75 mm	180 mm	1500 bar	400 lpm	RCS-75-24M.24MV
M36 x 2 M	M24 x 1.5 M	75 mm	200 mm	1500 bar	400 lpm	RCS-75-36M.24MV
3/4" - 14 NPS	3/4" UNF M LH	75 mm	154 mm	1500 bar	400 lpm	RCS-75-M12F. M12M
3/4" - 14 NPS 90°	3/4" UNF M LH	75 mm	154 mm	1500 bar	400 lpm	RCS-75-M12F. M12M 90°
M24 x 1.5 M	M24 x 1.5 M (long)	75 mm	225 mm	1500 bar	400 lpm	RCS-75-24FV.24MV-L

MAINTENANCE KITS

Description	Part No.
Major kit RCS75 1500 bar	RCS-75-300
Minor kit RCS75 1500 bar	RCS -75-100
Tool kit RC-S75 / SLC	RCS-SLC-500



DERC Mini Turret

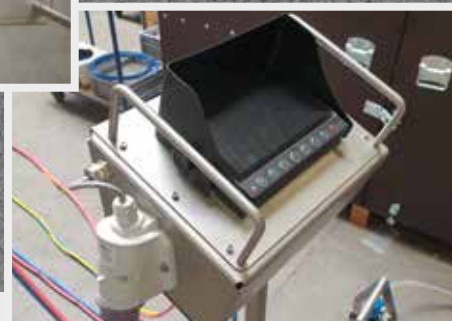

DERC Mini Turret

Scan for more info



THE PERFECT SOLUTION FOR CLEANING CONFINED SPACES, TANKS OR REACTORS

The DERC Mini Turret is an easy to install tool for automated cleaning of tanks or confined spaces. The base of the tool is a flanged base plate with on top the automated jetting arm. The jetting arm of the Mini Turret is designed in a way that it can move up/down, rotation +/- , nozzle up/down or oscillation. This allows the realisation of a 3D cleaning effect.

Light Weight Version or Stainless Steel

The Mini Turret can be supplied in an aluminium light weight version or in stainless steel. The stainless steel version is suitable to work both with high pressure or for chemicals.

Easy Operation

For easy operation the Mini Turret can be equipped with a camera system and monitor. The camera's are installed on the jetting arm, one near the flange and one next to the nozzle.

FEATURES

- Mini tank canon for cleaning confined spaces
- Air driven
- Unique and precise positioning
- Suitable for chemical and high pressure cleaning
- Fully automatic
- 3D cleaning effect

APPLICATION

- Cleaning confined spaces, tanks or reactors

SPECIFICATIONS

Max. Pressure	1000 bar
Max. Flow	130 lpm
Flange	16" 3000#
Reach	500-1500 mm under flange
Drive	Air
Movements	Nozzle 135° angle range oscillating, arm up/down, arm rotation
Nozzle	Model L/226 high speed jet
Material	Lightweight version aluminium approx. 60Kg / Stainless steel version approx. 90Kg
Options	Chemical cleaning set, swivel, nozzle manifold, automated rotation, 2 end switches installed so the Mini Turret rotates back and forth in a set angle/area, camerasystem

DERC Tank Cleaning Tools

DERC Tank Cleaning Tools

Scan for more info



POSITIONING TOOL PL.10000-H-M2

Max. Pressure	Model Lance	Angle	Diameter Flange	Connections
Depending on hose	Max. 8 m length	2x 45°	650 mm	Bronze guide bush on both sides, to protect the high pressure hose

POSITIONING TOOL PL.20000-L

Max. Pressure	Model Lance	Angle	Diameter Flange	Connections
1500 bar	1" high pressure lance, max. 6 m length	2x 45°	450 mm	1" BSP cleaning head, o-ring sealing on both sides. Nipples for all different tank cleaning units and hose connections

TANK CLEANING HEADS



AQUAMAT L 1500 PLUS	AQUAMAT XL 1600 PLUS	AQUAMAT XXL 1600 PLUS	AQUAMAT SELECT
Max. pressure: 1500 bar Flow rate: 300 lpm Tank opening: min. Ø 130 mm	Max. pressure: 1600 bar Flow rate: 450 lpm Tank opening: min. Ø 150 mm	Max. pressure: 1600 bar Flow rate: 700 lpm Tank opening: min. Ø 300 mm	Max. pressure: 1600 bar Flow rate: 500 lpm Tank opening: min. Ø 300 mm



BOLONDI XC061P	BOLONDI MW586A	BOLONDI RW086A
Max. pressure: 200 bar Flow rate: 60 lpm Tank opening: min. Ø 76 mm	Max. pressure: 500 bar Flow rate: 60 lpm Tank opening: min. Ø 140 mm	Max. pressure: 200 bar Flow rate: 60 lpm Tank opening: min. Ø 144 mm

POSITIONING TOOLS & TANK CLEANING HEADS

DERC Positioning Tools TWK

The DERC Positioning Tools makes it easy to position and fixate your tank cleaning head inside a vessel or storage tank.

Three Models

The PL.10000-H-M2 comes with a hollow guide tube, to fit a high pressure hose. The PL.20000-L is equipped with a high pressure rigid lance. The FPK-TWK-24" is designed to position the tank cleaning head through a 24" manhole.



FEATURES POSITIONING TOOLS

- Inspection cover
- Stainless steel construction
- Place at an angle

APPLICATION

- Tank or vessel cleaning

Tank Cleaning Heads

DERC Salotech offers a full range of compatible Aquamat and Bolondi high pressure tank cleaning heads.

CALL US +31 186 - 62 14 84

DERC Abrasive Cutting System Flexa-Jet

DERC Abrasive Cutting System Flexa-Jet

Scan for VIDEO

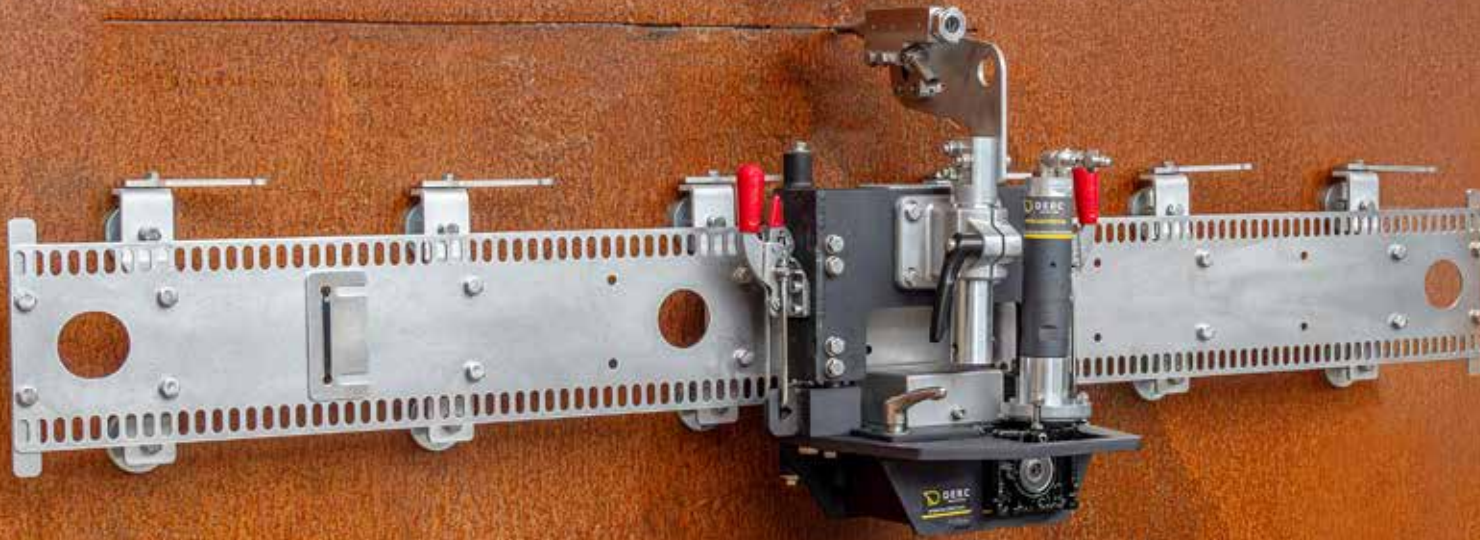

YOUR ULTIMATE FLEXIBLE SOLUTION FOR WATER JET ABRASIVE CUTTING

The Flexa-Jet Cutting System is designed for industrial cold cutting using ultra-high pressure water. This innovative system combines simplicity, accuracy, and versatility.

Flex-Jet Tractor

The base of the system is the Flexa-Jet Tractor, suitable for use with both the Flexa-Jet Track and Pipe Bands. It features direct drive onto the track and pipe band, ensuring continuous movement, with a standard gear that is easy to change for different speeds/ratios.



FEATURES

- Flexa-Jet Tractor, direct drive
- Flexa-Jet Track with vacuum pads, permanent magnets or switchable magnets
- Cutting nozzle
- Hopper with abrasive monitoring system
- Control panel

APPLICATIONS

- Industrial cold cutting

CALL US +31 186 - 62 14 84



Hopper

The abrasive which runs to the cold cutting head is stored into the hopper. This hopper is dolly mounted for easy transportation on the job site. The abrasive feed rate is controlled by the abrasive monitoring device ensuring a constant well adjustable flow of abrasive. The feeding of the abrasive is done by the venturi inside the nozzle.



BASIC CUTTING SET

Part No.	Description
D.CUT.TRACK.PM	Flexa-Jet Track direct drive - 1,5 m stainless steel spring steel with permanent magnets
D.CUT.TRACK.SM	Flexa-Jet Track direct drive - 1,5 m stainless steel spring steel with switchable magnets
D.CUT.TRACK.VP	Flexa-Jet Track direct drive - 1,5 m stainless steel spring steel with vacuum pads
D.CUT.POWERHEAD	Flexa-Jet Tractor direct drive complete (air), delivered complete with cutting head holder to cut parallel and perpendicular
D.ABHOPPER.AS-B	Hopper assembly stainless steel trolley, complete with abrasive monitoring system and abrasive transport hose
CPA-AWCS	Control panel for abrasive cutting system, complete with 3 hoses
CPA-AWCS-VAC	Control panel for abrasive cutting system, complete with 3 hoses, for vacuum pads
D.ABCUTTIN.AS	Cutting nozzle assembly complete 3000 Bar

DERC Abrasive Cutting System Flexa-Jet

DERC Abrasive Cutting System Flexa-Jet

Scan for VIDEO

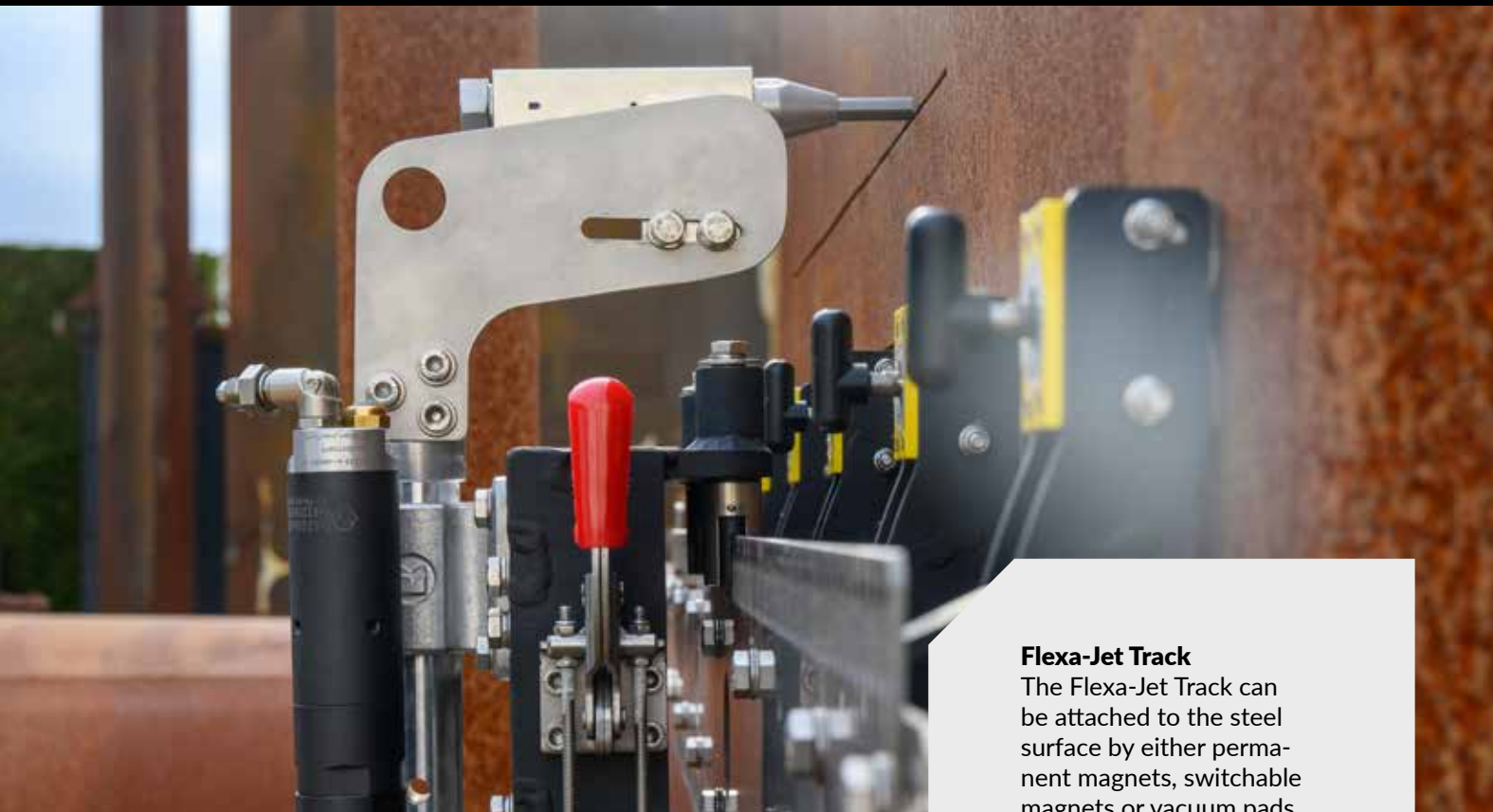

Flexa-Jet Track
The Flexa-Jet Track can be attached to the steel surface by either permanent magnets, switchable magnets or vacuum pads.



FLEXA-JET TRACK - SWITCHABLE MAGNETS

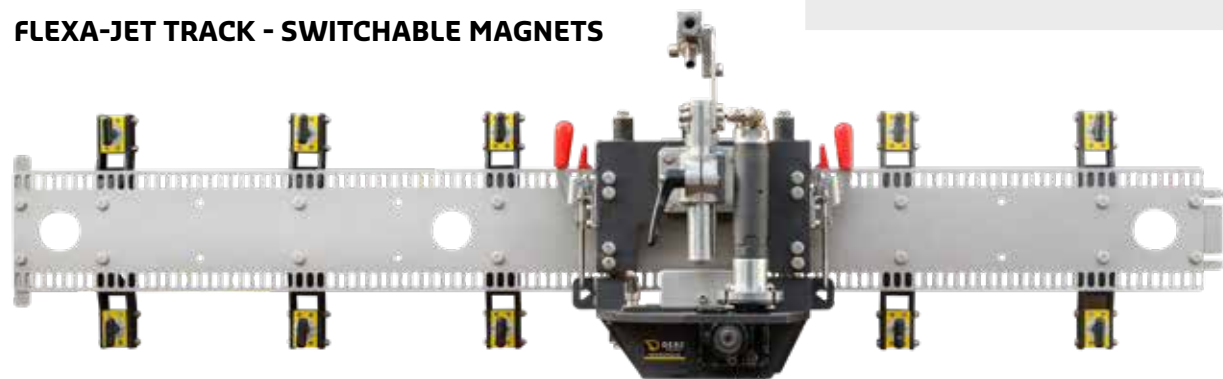

FLEXA-JET TRACK - PERMANENT MAGNETS

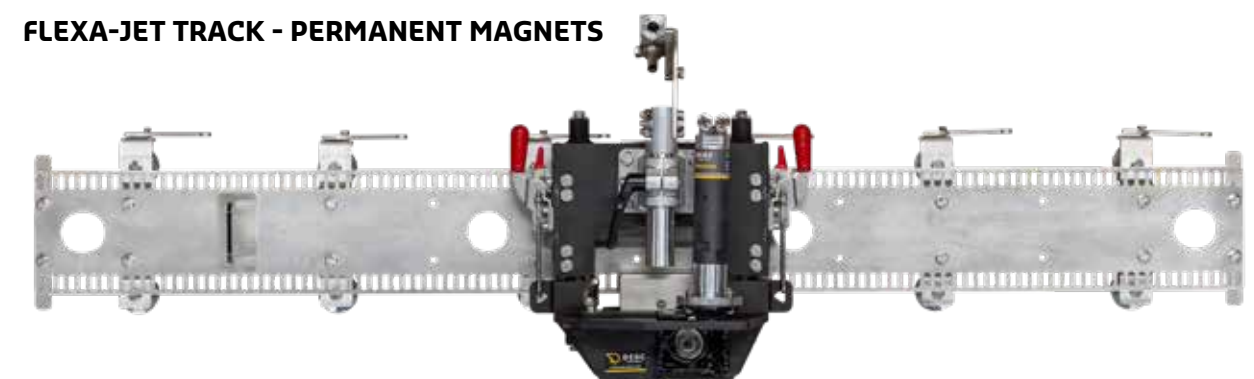

FLEXA-JET TRACK - VACUUM PADS

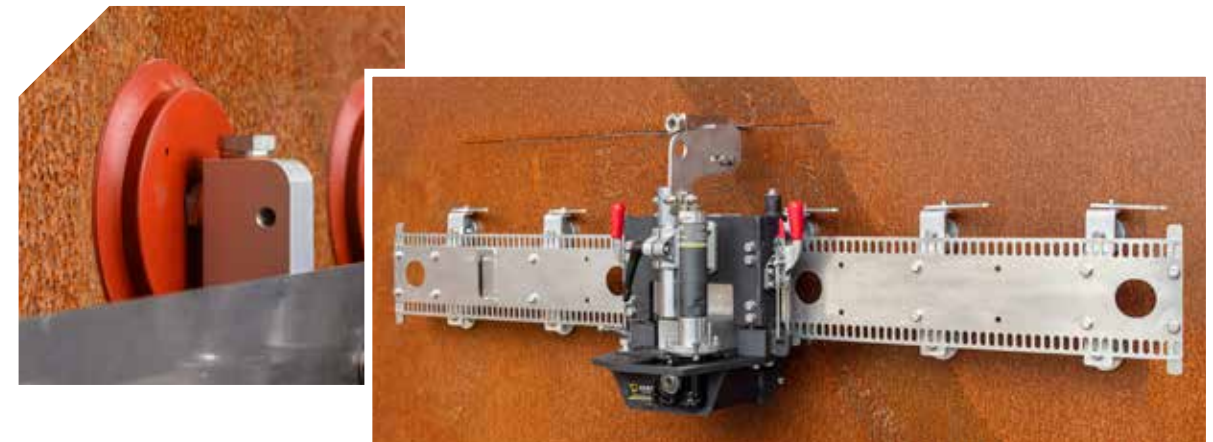

CALL US +31 186 - 62 14 84

DERC Abrasive Cutting System Flexa-Jet



12" PIPE BAND

REDUCER BLOCKS FOR 12" PIPE BAND

Flexa-Jet Pipe Bands

These curved tracks wrap around pipes for precise pipe cutting. One pipe band with reducer blocks is used for 6"-10" pipes, while separate pipe bands are available for 12"-24" pipes.

DERC Abrasive Cutting System Flexa-Jet

Scan for VIDEO

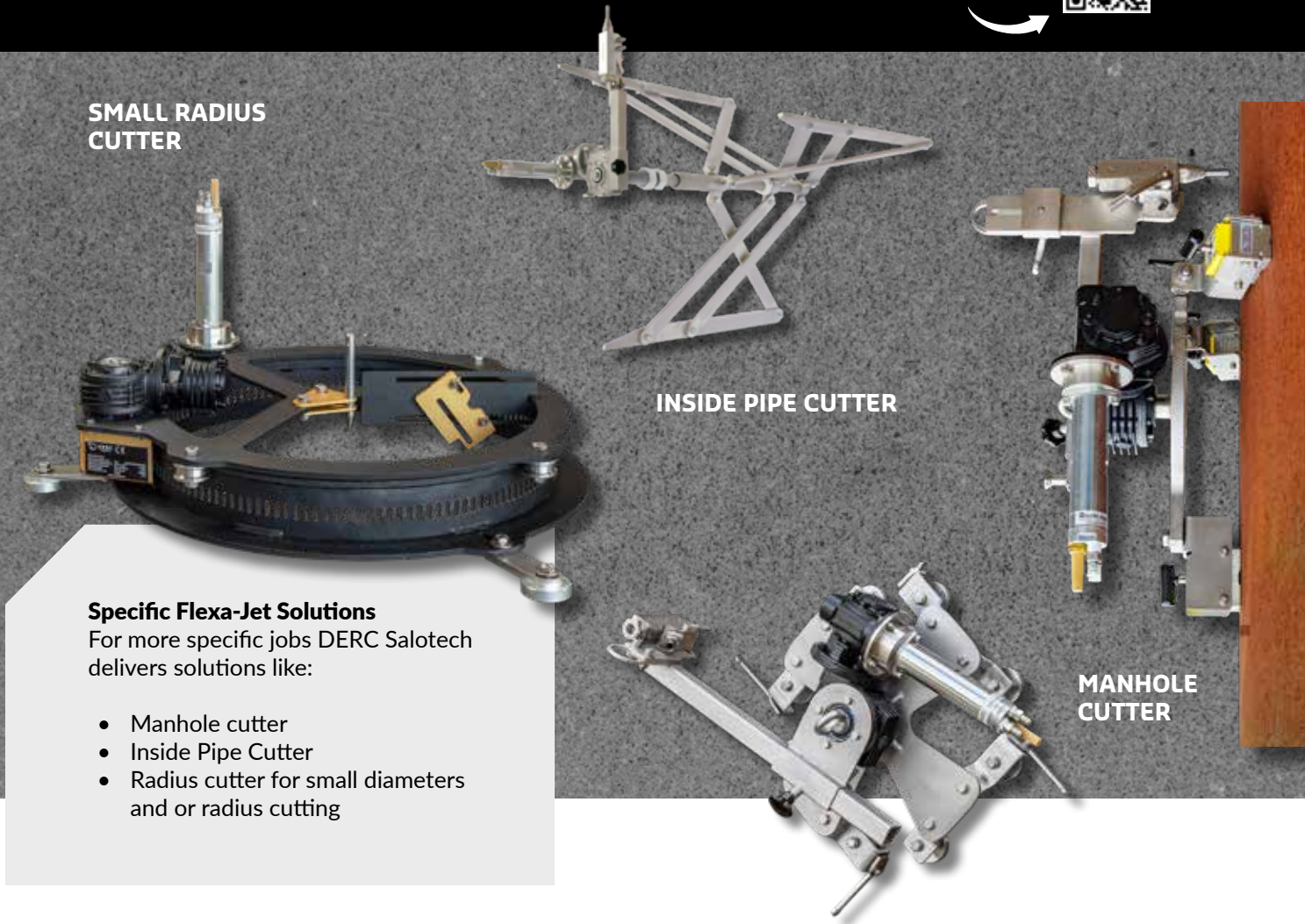

SMALL RADIUS CUTTER

INSIDE PIPE CUTTER

MANHOLE CUTTER

Specific Flexa-Jet Solutions

For more specific jobs DERC Salotech delivers solutions like:

- Manhole cutter
- Inside Pipe Cutter
- Radius cutter for small diameters and or radius cutting

OPTIONAL FLEXA-JET PIPE BANDS

Part No.	Description
D.PB.12	Pipe band 12" direct drive
D.PB.14	Pipe band 14" direct drive
D.PB.16	Pipe band 16" direct drive
D.PB.18	Pipe band 18" direct drive
D.PB.20	Pipe band 20" direct drive
D.PB.24	Pipe band 24" direct drive
D.PB-RB-6	Reducer block set for reducing 12" pipe band to 6"
D.PB-RB-8	Reducer block set for reducing 12" pipe band to 8"
D.PB-RB-10	Reducer block set for reducing 12" pipe band to 10"

SPECIFIC SOLUTIONS AND OPTIONAL ACCESSORIES

Part No.	Description
D.ABMCUTTER.AS	Manhole Cutter (air) DN450-800 with permanent magnets
D.ABMCUTTER.AS-RMAG	Manhole Cutter (air) DN450-800 with releasable magnets
D.RADCUTTER	Radius Cutter (air) DN50 - DN450
D.AB.IC.XX	Inside Pipe Cutter Tool
D.ABCUTTIN.03	Spare cone TC for cutting nozzle
D.ABCUTTIN.10	Spare slurry nozzle TC for cutting nozzle 2,5mm
D.ABCUTTIN.10.20	Spare slurry nozzle TC for cutting nozzle 2,0mm
D.ABCUTTIN.10.30	Spare slurry nozzle TC for cutting nozzle 3,0mm
965.XXX	HP nozzle M10 model 965

DERC MagTrack

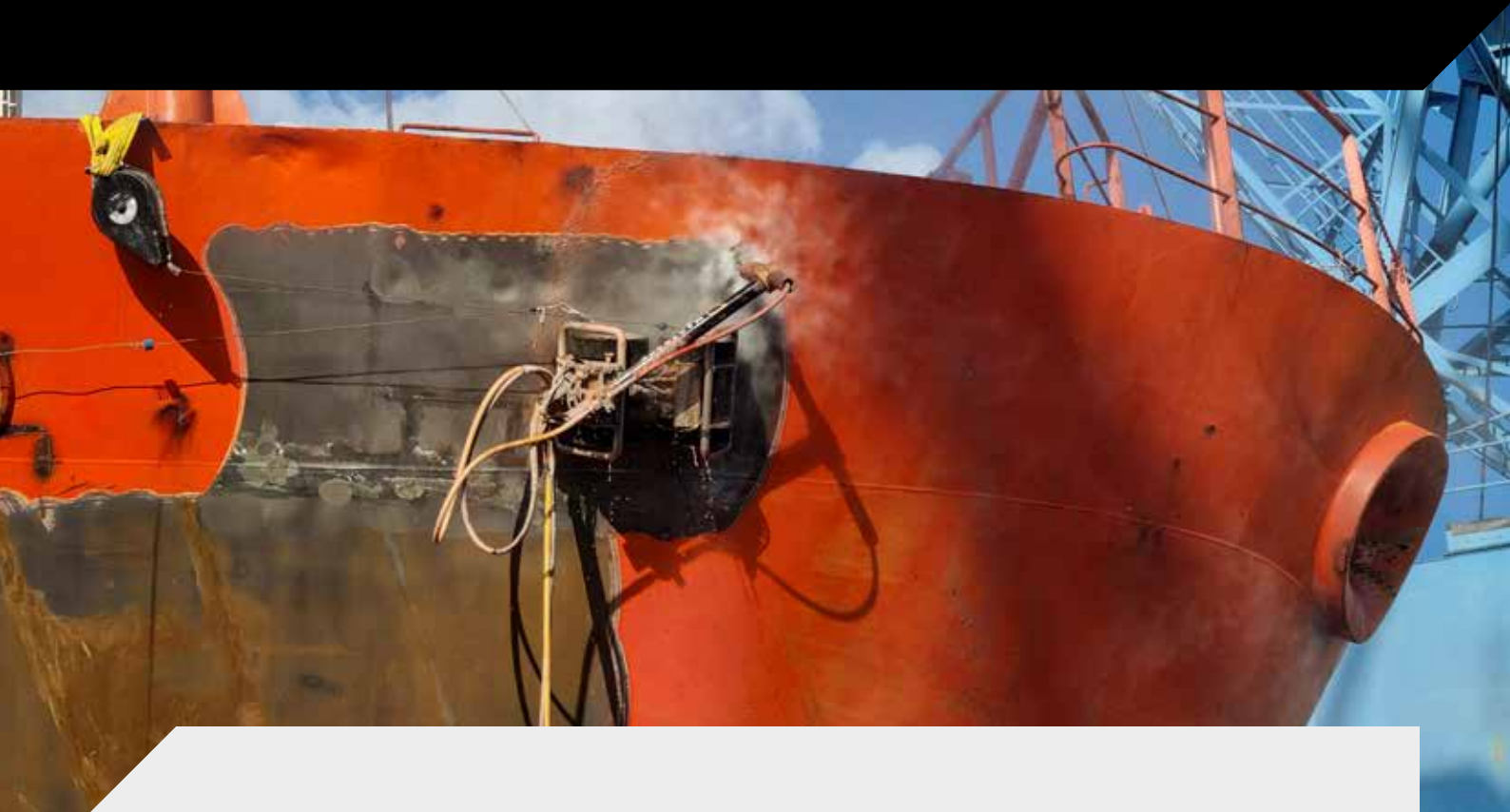

MODULAR MAGNETIC CRAWLER FOR SURFACE PREPARATION

The DERC MagTrack robots are magnetic crawlers, electrically driven, suitable for multi purpose applications. MagTrack is a modular system that is built around an universal carrier.

The crawlers are designed to be used on flat and curved steel surfaces. Depending on the application, the carrier can easily be fitted with a full range of modular tools, either based on water jetting or abrasive (sand)blasting. All water jetting tools work with high pressure jets up to 3000 bar.

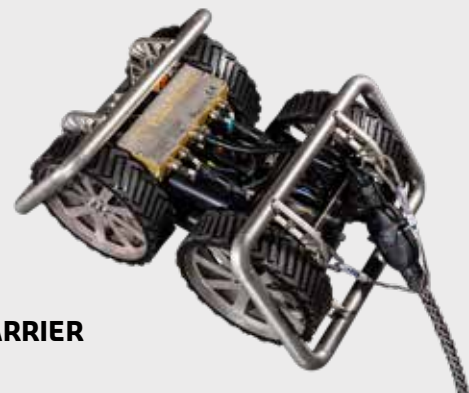

CARRIER

CALL US +31 186 - 62 14 84

FEATURES

- Compact design, fits through a 24" manhole
- No more scaffolding or cherry pickers
- Can be operated by one man
- Low in maintenance
- Set-up in 30 minutes
- ATEX zone II certified (water jetting)
- Remote controlled

APPLICATIONS

- Surface preparation
- Oil storage tank cleaning
- Industrial cleaning and washing
- Cargo hold cleaning
- Abrasive blasting
- Inspection
- Waterjet cutting

DERC MagTrack

Scan for VIDEO

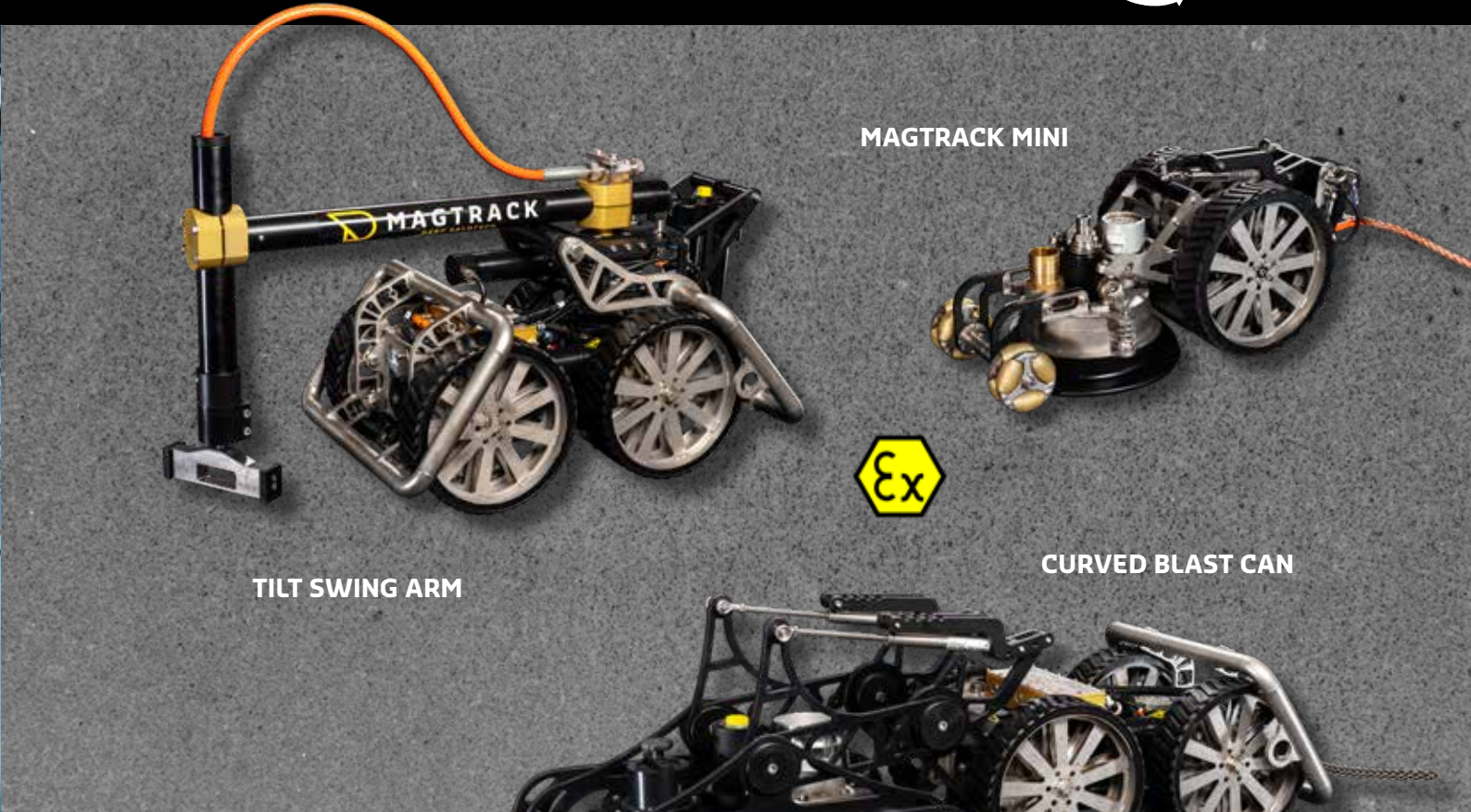

TILT SWING ARM

MAGTRACK MINI

CURVED BLAST CAN



WATER JETTING TOOLS:

- **(Tilt) Swing Arm**
Open waterblasting for industrial (tank) cleaning and surface preparation (ship hulls for example)
- **Blast Can**
Closed waterblasting for industrial (tank) cleaning and surface preparation (ship hulls for example)
- **Curved Blast Can (Patented)**
Closed waterblasting for small storage tanks and highly curved surfaces
- **MagTrack Mini**
Closed waterblasting for cleaning round/straight surfaces, easy to transport

Scan for VIDEO



DERC MagTrack

DERC MagTrack

Scan for VIDEO



RECYCLEBLASTER



SAND BLASTING TOOLS:

- **Sandblaster Swing Arm**
Open sandblasting for surface preparation (ship hulls for example)
- **Sandblaster (Tilt) Swing Arm**
Open sandblasting for surface preparation
- **RecycleBlaster**
Closed circuit sandblasting for surface preparation (ship hulls for example)



SANDBLASTER TILT SWING ARM



MAGTRACK ACCESSORIES

- **Main Control Unit**
Powers and controls the MagTrack robot (ATEX optional)
- **Remote Controller**
Operate the MagTrack at a safe distance
- **Fall Arrestor (optional)**
To safely secure your MagTrack when working on vertical surfaces
- **Transport Plate**
For easy transport and safe deployment to the surface
- **LED Lights (optional)**
Optional ATEX lights to increase visibility inside (oil) storage tanks
- **Wall Contact Switch (optional)**
When MagTrack detaches from the surface it automatically switches off the high pressure water



DERC Hydro-Jet Mower

DERC Hydro-Jet Mower

Scan for more info



ROTATING SURFACE CLEANER

The DERC Hydro-Jet-Mower is a rotating surface cleaner for cleaning floors, grates, decks or other surfaces with high pressure water jets. The base is a stainless steel 4-wheel carriage with an ergonomic adjustable push bar. We offer two models with different maximum working pressure: 1500 bar / 22K and 3000 bar / 43K.

Options

The Hydro-Jet Mower can be supplied with the following options:

- Vacuum Attachment: double dome vacuum ring model with 3" connection 90°. Completely installed.
- Mechanical Dump Valve: High Pressure Dump Valve 1500 bar/ 22K PSI or 3000 bar / 43K PSI complete installed with controls to push bar.
- Electric Control: electric pressure on/off switch complete installed with controls to push bar. Supplied with necessary plug 4 or 7 Pin.
- Standard 6 weight plates included, with possibility to order more.

FEATURES

- Stainless steel carriage
- 4-Wheel, 2 fix, 2 flex zinc plated
- Push bar adjustable with hand grips
- Rubber sealing
- 4-jet arm manifold (1500 bar version)
- 6-jet arm manifold (3000 bar version)
- 1500 bar / 22K PSI or 3000 bar / 43K PSI

APPLICATION

- Cleaning floors, grates, decks and other surfaces

SPECIFICATIONS

Dimensions (L x W x H)	1275 x 470 x 1100 mm
Cleaning Path	400 mm
Weight (excl. plates)	53 / 55 kg
Weight Plate	5 kg
Max. Pressure	1500 or 3000 bar
Max. Flow 1500 bar	140 lpm
Connection 1500 bar	M24x1,5 female flat
Type Insert Nozzle 1500 bar	DS14-XXX
Max. Flow 3000 bar	75 lpm
Connection 3000 bar	1 1/8"-12 UNF female
Type Insert Nozzle 3000 bar	964.XXX
Vacuum Connection	3" camlock
Max. Rotation Speed	2500 rpm
Max. Temperature	70 °C

OPTIONS 1500 BAR / 22K PSI MODEL

Description	Part No.
Basic Surface Cleaner	DHM-1500-18
Vacuum Attachment	DHM-VA-3
Dump Valve	DHM-DV-1500
Electric Control (plug 4 or 7 pin)	DHM-EC-4 or DHM-EC-7

OPTIONS 3000 BAR / 43K PSI MODEL

Description	Part No.
Basic Surface Cleaner	DHM-3000-18
Vacuum Attachment	DHM-VA-3
Dump Valve	DHM-DV-3000
Electric Control (plug 4 or 7 pin)	DHM-EC-4 or DHM-EC-7

DERC Rotary Coupling Swivel RCS-500

DERC Rotary Coupling Swivel RCS-500

Scan for more info



PNEUMATIC OR HYDRAULIC BELT DRIVEN CLEANING TOOL

The DERC RCS-500 is a fast rotation tool, which is belt driven to operate till 1.000 rpm. The DERC RCS-500-A uses an air motor and the DERC RCS-500-H is powered by a hydraulic motor.

Powered rotation units control rotation speeds and allow the use of a wide variety of head configurations for diverse cleaning applications.

FEATURES

- Fast rotation cuts deposits quickly with less striping or effect on the surface
- Radiused arms produce powerful and effective jets
- Adaptable head configuration can be customized for a large range of applications
- Replaceable nozzle tips maximize jet quality

APPLICATIONS

- External tube bundle cleaning, mounted on a rail and tractor System
- Floors, conveyors and large surfaces
- Surface preparation

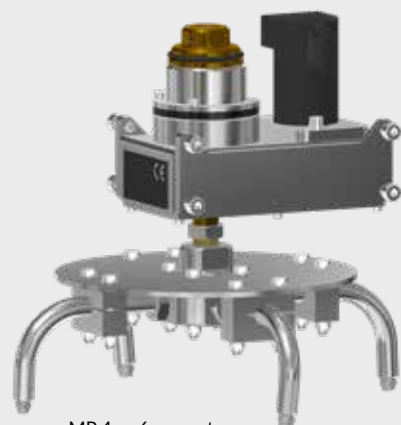

MP 4 or 6 arm rotor

CALL US +31 186 - 62 14 84

DERC RCS-500-A

Max. Pressure	Inlet Connections 0° or 90°	Drive	Rotation Speed	Max. Flow
1000 bar	3/4" NPT	Air	1000 rpm	190 lpm
1500 bar	M24x1,5, 3/4" NPS	Air	1000 rpm	155 lpm
3000 bar	1 1/8" UNF	Air	1000 rpm	75 lpm

DERC RCS-500-H

Max. Pressure	Inlet Connections 0° or 90°	Drive	Rotation Speed	Max. Flow
1000 bar	3/4" NPT	Hydraulic	1000 rpm	190 lpm
1500 bar	M24x1,5, 3/4" NPS	Hydraulic	1000 rpm	155 lpm
3000 bar	1 1/8" UNF	Hydraulic	1000 rpm	75 lpm

OPTIONAL ARMS AND HEADS

Arm Type	Nozzle Type	Max. Pressure	
RCS-230B-M20-T4	Type 04 nozzles	1500 bar	Complete with flow stabilizers and nozzle caps
RCS-230B-M20-T226	Type 226 nozzles	1000 bar	Complete with flow stabilizers and nozzle caps
RCS-230B-14NF	DI 14 nozzles	1000 bar	With integrated flow inducer

Arms and heads for 3000 bar version can be configured on request

RD Masterjet



The RD Masterjet rotor jets convert the high effectiveness of round jet nozzles into area performance through rotating nozzle heads. It has an optimum internal flow, which allows the pump's total performance to be used without loss of energy. Various nozzle configurations and adjustable speeds open up many possibilities for surface treatment.



SPECIFICATIONS

Part No.	Connection	Max. Flow
2/4 nozzles	1800 bar	60 lpm
2/4 nozzles	3200 bar	50 lpm
2/4 nozzles "ATEX"	3200 bar	50 lpm
2/4 nozzles "Low Flow"	3200 bar	20 lpm
5 nozzles	3200 bar	50 lpm
3/6 nozzles	1800 bar	60 lpm
3/6 nozzles	3200 bar	50 lpm



Features Masterjet

- High energy efficiency
- Versatile; 2, 3, 4, 5 or 6 nozzle inserts
- Variable rotation speed (1000 - 3500 rpm, 3 settings available)
- Speed adjustable by moving outer sleeve
- Easy maintenance
- Max. working pressure 3200 bar / 46K

Monro-Jet Nozzles



MONRO-JET® nozzles combine the high power of the point jet with the large area output of the flat jet. They can be used with all approved high-pressure fittings and mounted on lances.

There are six different models. The operating pressure ranges from 500 bar up to 2500 bar, depending on the model. For each model there are also different connection thread types available.



MONRO-JET F1
1500 bar



MONRO-JET F3
800 bar



MONRO-JET F2
1000 bar



MONRO-JET F4
500 bar



MONRO-JET F6
500 bar



MONRO-JET F25
2500 bar



MONRO-JET REPAIR KITS

DERC Hydraulic Hose Reel

DERC Hydraulic Hose Reel

Scan for more info



SMOOTH AND CONTROLLED (RE)TRACTION OF HOSES

Versatile Functionality

DERC Salotech provides cutting-edge hydraulic hose reel solutions for efficient cleaning of long pipelines. Our high-pressure hose reels are designed to handle up to 3000 Bar/43,000 PSI, making them ideal for demanding tasks. They are suitable for both storage and water jet pipe cleaning purposes, offering versatile functionality.

Simplifying Cleaning Operations

The hydraulic drive system ensures smooth and controlled (re)traction of the hose, simplifying handling during cleaning operations.



FEATURES

- Hydraulic drive
- Automated retraction of hoses
- Rugged steel construction
- Up to 3000 bar

APPLICATIONS

- Smooth and controlled (re)traction of hoses during cleaning operations
- Storage of (high pressure) hoses

Custom Solutions

DERC Salotech has extensive experience in designing and supplying high-quality hose reels, tailored to different applications. Whether you need a reel for storage purposes or to facilitate water jet pipe cleaning, we can assist you in finding the right solution for your needs. By choosing our hydraulic hose reel solutions, you can enhance productivity and streamline your cleaning processes.

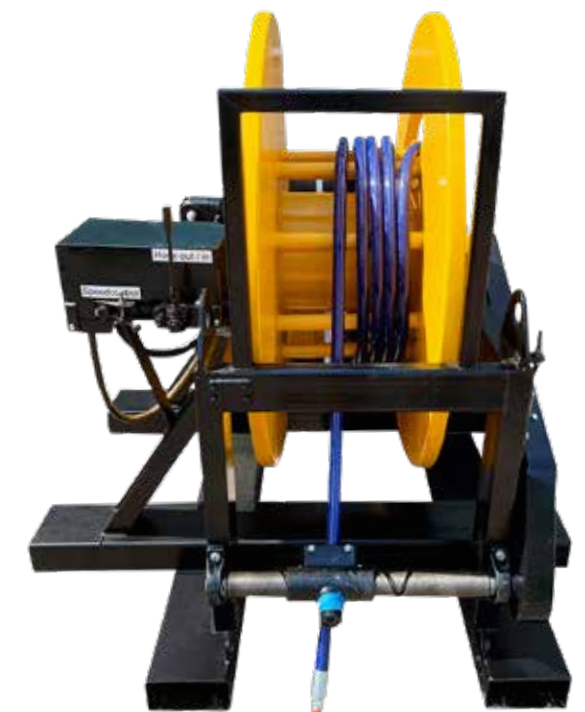

CALL US +31 186 - 62 14 84

DERC Air PreHeater Cleaner APC (XXL)

DERC Air Preheater Cleaner APC (XXL)

Scan for more info

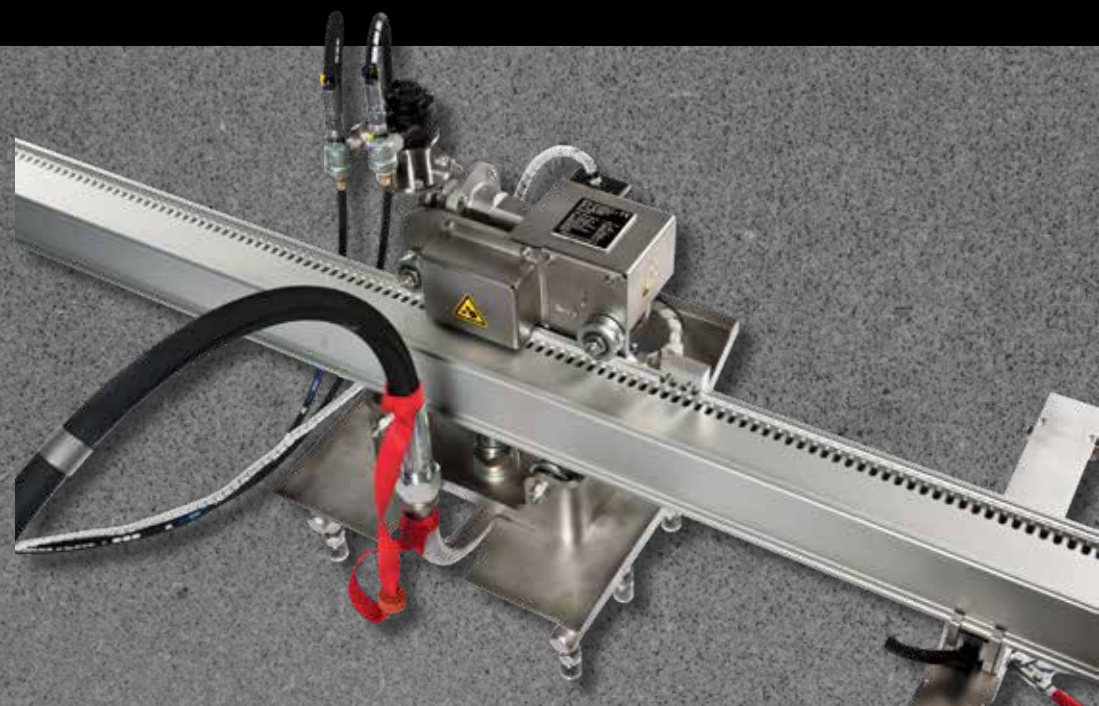

PLC CONTROLLED WATER JETTING OF AIR PREHEATERS

The DERC PLC-controlled Air Preheater Cleaner is a full automatic PLC controlled Air Preheater Cleaner with touch screen interface. We offer two versions.

Air Preheater Cleaner

The Air Preheater Cleaner operates on an aluminum rail with slotted holes for precise carriage movement. The rail, secured with two clamps, is mounted inside and outside the air preheater. An electric motor with an encoder and PLC ensures highly accurate positioning of the cleaning manifold (± 1 mm).

Manifold with 4 - 5 Nozzles

The cleaner includes a high-pressure manifold, available in 4- or 5-jet configurations, with a maximum pressure of 700 bar (10K). The cleaner's capacity depends on the rail span. For higher flows or pressures, the XXL version is recommended.

Operation at a Safe Distance

The operator operates the Air Preheater Cleaner with the touch screen, at a safe distance, outside the air preheater.

FEATURES

- PLC controlled
- Touch screen control
- Parameters programmable
- Fully electric control
- Data logging possible
- Different types of manifolds possible
- Linkable to your high pressure unit(s)
- Double-sided cleaning (top and bottom)

APPLICATIONS

- Automated cleaning of air preheaters

Air Preheater Cleaner XXL

This APC XXL-version is able to clean a rotating air preheater with a diameter of 19 meters at a very high capacity of 2x 1000 litre per minute at 500 bar/ 7K. The Air Preheater cleaner XXL moves on a sectionalized guide rail of 10,5 metre and can be positioned very fast with high precision (± 1 millimeter).

Manifold with 14 Nozzles

An electrically powered carriage with ball-bearing wheels moves the manifold. Each manifold holds 14 nozzles (2x M42 DKOS).



CALL US +31 186 - 62 14 84

DERC Scaffold Cleaner

DERC Scaffold Cleaner

Scan for VIDEO



NEW



SAFE AND AUTOMATED CLEANING OF SCAFFOLDING PLANKS

The Scaffold Cleaner is a cutting-edge solution designed to maintain the cleanliness and safety of metal scaffold planks. Engineered for optimal performance, this machine efficiently removes dirt, debris, and contaminants from the upside of scaffold planks, ensuring a safer working environment. The Scaffold Cleaner is user-friendly, durable, and compatible with high-pressure units, making it an essential tool for any construction site.

Operation

The Scaffold Cleaner operates by feeding scaffold planks through the roller bed into the cleaning box, where the height-adjustable cleaning head uses high-pressure water jets to clean the upside of the planks. The cleaned planks are then fed out through the roller bed on the opposite side. The control system allows for precise adjustments and safe operation, ensuring optimal cleaning performance.

FEATURES

- Up to 3000 bar
- Automated feeding of planks
- Cleaning head driven by RCS-500
- Manifold with 20 nozzles

APPLICATIONS

- Cleaning of scaffolding planks

The Scaffold Cleaner consists of three main components:

Roller Bed: This component includes a feed-through system for plank input and output, ensuring smooth and efficient handling of the planks.

Cleaning Box: Equipped with a height-adjustable, pneumatically driven cleaning head, the cleaning box effectively removes dirt and contaminants from the planks.

Control System: The electric control box features various controls such as Emergency Stop (E-stop), Reset, Feed-through Speed Control, Cleaning Activation, and Rotation Speed Control.



CALL US +31 186 - 62 14 84

DERC Hydroblast 4+ Hose



VERSATILE RUBBER HIGH PRESSURE HOSE

The DERC HYDROBLAST 4+ industrial high pressure hose is specially developed for the high pressure cleaning industry.

Up to 1100 Bar

The hose is capable of working pressures until 1100 bar and is produced with only 4 spiral layers, so a 3/4" hose is still manageable.

Light Weight and Flexible

The hose has a short bend radius, is light weight and can be used with a water temperature up to 80° C.

Versatile

The Hydroblast 4+ hose is available with NPT or metric couplings. And with 90° bended couplings M24 and M36.

Sizes

The hose is available in 3/8" (DN10), 1/2" (DN12) and 3/4" (DN20).

FEATURES

- Suitable for high temperature till 80° C
- Light weight and flexible
- Resistant outer core
- Certified according the latest NEN standards
- Bigger bore couplings, less pressure loss
- Available with safety marking rings or safety hose catcher rings

APPLICATIONS

- Industrial high pressure hose

DERC Hydroblast 4+ Hose

Scan for more info



DERC HYDROBLAST 4+

Model	HB4T.10.24.20	HB4T.12.24.20	HB4T.20.36.20
Inside Diameter	3/8" (9.5 mm)	1/2" (12.6 mm)	3/4" (19 mm)
Outside Diameter	20.4 mm	24.6 mm	32.0 mm
Bend Radius	210 mm	230 mm	250 mm
Length	20 - 100 m	20 - 100 m	20 - 60 m
Max. Pressure	1250 bar	1100 bar	1100 bar
Test Pressure	1875 bar	1650 bar	1650 bar
Burst Pressure	3125 bar	2750 bar	2750 bar
Weight	0.88 kg/m	1.22 kg/m	1.87 kg/m



SPIR STAR Hoses

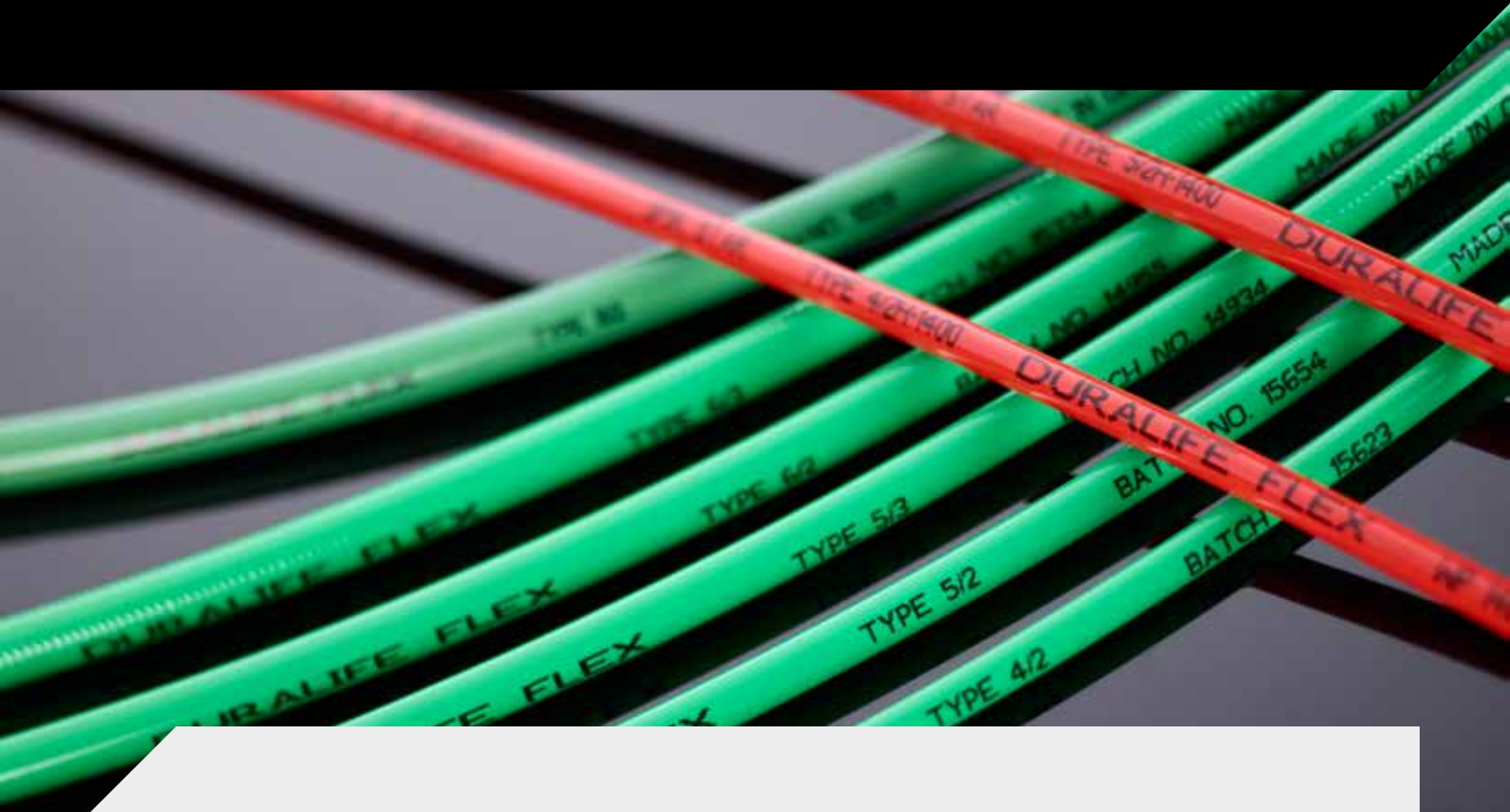

THERMOPLASTIC HIGH PRESSURE HOSES

DERC Salotech supplies SPIR STAR thermoplastic high-pressure hoses for waterblasting, reinforced with spiralized high tensile steel. Available in 2, 4, 6, and 8 layers, these hoses handle pressures up to 4000 bar, making them essential for various waterblasting applications.

SPIR STAR hoses offer minimal volumetric expansion, lightweight, and high external pressure resistance. They also produce hoses for extreme temperatures (up to 150°C) and chemical resistance. With the capability to manufacture hoses up to 4500 meters long, SPIR STAR is a leading supplier for major oil companies and the only producer of PVDF hoses.

FEATURES

- Reinforced with spiralized steel
- Available in 2, 4, 6 and 8 layers
- Up to 4000 bar
- Inner diameters from 3 mm to 32 mm
- Suitable for various applications

APPLICATIONS

- Waterblasting
- High Pressure Hydraulics
- Oil and Gas Offshore
- Hydrogen industry



CALL US +31 186 - 62 14 84

SPIR STAR Hoses

Scan for more info



Assembly Center

DERC Salotech is a certified assembly center for SPIR STAR hose assemblies. Our trained and experienced team ensures the highest standards of quality and safety, staying up to date on SPIR STAR assembly practices. By assembling hoses in-house, we offer fast delivery and reliable repair services.



Applications

- **Water Blasting:**
Heat exchanger cleaning, tank cleaning, concrete demolition, pipe and tube cleaning.
- **High Pressure Hydraulics:**
Bolt tensioning, rescue tools, autofrettage, hydro forming.
- **Oil and Gas Offshore:**
Offshore hose bundles, methanol service on platforms, chemical injection, hydraulic control. Special hose models: HT Series, PPA Series, M Series.
- **Hydrogen Industry:**
Hydrogen hoses for vehicle refueling at 350 and 700 bar, certified to ISO 19880-5 and SAE J2601 standards. Transfer hoses for larger flows used on H2 trailers, ships, and trains.

DERC Hose Catchers



THE SAFE WAY FOR MANUAL CLEANING PIPES, TUBES OR HEAT EXCHANGERS

DERC Salotech designed a complete line of Hose Catchers, which provide a safe way of cleaning pipes manually.

Ultimate Protection

When cleaning pipes and tubes there is a risk the nozzle could come out of the pipe backwards. To protect the operator DERC Salotech offers a full range of Hose Catchers.

Hose Catcher for Every Job

The DERC Hose Catchers are available in the following types:

- VE.20000 for cleaning pipe lines
- VE.21000-22000 for cleaning pipes in small spaces
- VE.40000 for cleaning vertical heat exchangers
- VE.70500 for cleaning heat exchangers
- VE.80000 for cleaning larger pipes (up to 400 mm OD)

FEATURES

- Stainless steel construction
- Adaptable to different pipe sizes
- Easy and fast mounting
- Hose stoppers in different sizes

APPLICATION

- Protecting operator when manual cleaning pipes, tubes or heat exchangers

CALL US +31 186 - 62 14 84

DERC Hose Catcher VE.20000



The DERC Hose Catcher VE.20000 is specially constructed as an adjustable accessory tool for the safe high pressure cleaning of pipe lines, by means of a hose with a jetting nozzle mounted on the end. Hoses of different diameters can be used due to the adjustable clamp.

Optional Equipment VE.20000

The VE.20500 Extension Kit consists of two stainless steel square tubes, which make it possible to connect the VE.20000 to bigger diameter pipes or shells.

The easy to connect VE.20600 Hook On Kit makes it possible to strap the Hose Catcher VE.20000 onto non-flanged pipe lines.



Hose Stoppers

Every Hose Catcher, except the VE.20000, VE.21000 and VE.22000, is equipped with hose stoppers for different flex hoses diameters.

The hose stopper ensures that the hose stops at the right moment. The stoppers can be stored in the cassette, which is located on the Hose Catcher, to keep everything together.

DERC Hose Catcher VE.21000-22000



The VE.21000-22000 Hose Catcher is especially designed to work with flex lances in small spaces. This Hose Catcher can be mounted on a flange of a pipe between 3" and 6" and can be supplied without a splash plate (VE.21000) or with a splash plate (VE.22000). It is also possible to store the different hose stoppers in an optional storage box (VE.21500).

Features VE.21000-22000

- Easy mounting on the flange of a pipe
- Suitable for horizontal and vertical applications
- Supplied with or without splash plate
- Splash plate available in different sizes



DERC Hose Catcher VE.40000



The DERC Hose Catcher type VE.40000 is specially constructed as an adjustable accessory tool for the safe manual high pressure cleaning of vertical heat exchangers with flex lances. Hoses of different diameters can be used due to various hose stoppers. We supply the vertical tube in a variety of dimensions.



DERC Hose Catcher VE.70500



The DERC Hose Catcher type VE.70500 is a specially constructed adjustable auxiliary tool for cleaning pipe bundles by means of a hose with a jetting nozzle mounted to the front. All the pipes in the bundle can be reached because of the construction with two hinged points.

The advantage of the modular construction of the hose catcher is that an adaptor can be mounted to a foot pedal so that a vertical heat exchanger can be cleaned. Besides this the hose catcher can be used for one single pipe after removal of the hinged arm. The hose catcher can be mounted to a pipe or heat exchanger in various ways.

Flex hoses of different diameters can be used due to the various diameters of the interchangeable Hose Stoppers.

A round transparent (Lexan) plate has been mounted on to protect the operator from backsplash water.



DERC Hose Catcher VE.80000



The DERC Hose Catcher type VE.80000 is a specially constructed adjustable auxiliary tool for safe high pressure cleaning of pipes by means of a hose with a jetting nozzle mounted to the front.

The Hose Catcher consists of a stainless steel base plate with 3 connections; one for 1/2", one for 3/4" high pressure hoses and one for flex lances in various diameters. Flex lances of different diameters can be used due to the various diameters of the interchangeable Hose Stoppers. These Hose Stoppers are stored in the cassette to prevent losing them. The 1/2" and 3/4" connections are nuts which function as hose stoppers. All parts are as much as possible fixed to the base plate to keep everything together.

The Hose Catcher can be mounted on the pipe in various ways; mountable clamps, bolts or when there is no flange, with lashing.



DERC Hose Safety Systems



FOR SAFE USAGE AND CONNECTING HIGH PRESSURE HOSES

DERC Salotech offers the following safety products for using and connecting hoses:

DERC Hose Fixation Sling

DERC Salotech offers Hose Fixation Slings for securing vertical lined up hoses; a reliable connection point that adapts to numerous anchor points.

DERC Hose Grips

Hose Grips are used as security between high pressure hoses in case the hose connection would fail. All Hose Grips and Whip Checks are supplied with a controlled quality declaration.

DERC Hose Whip Checks

The Hose Whip Checks are required as safety measure to avoid injury in case of hose or coupling failure. The Hose Whip Check is an advanced and innovative version. Improved, safer and stronger designed for the (high) pressure hydraulic and water jetting market.

FEATURES HOSE WHIP CHECKS

- Steel internal wire covered with Kevlar and Polyester
- Loop design, it pulls tighter and tighter
- Suitable for small and bigger hose diameters
- Soft on the hands, no wires

APPLICATION HOSE SAFETY SYSTEMS

- Protecting operator when using and connecting high pressure hoses

CALL US +31 186 - 62 14 84

DERC Hose Fixation Sling



SPECIFICATIONS

Static Strength	22 kN
Working Length	120 cm
Webbing	20 mm
Safety Standard	EN 795 class B
Part No.	SIR.3



DERC Hose Grips



SPECIFICATIONS

Part No.	Diameter	Length
HG1.400.SS	Ø 7-14 mm	400 mm
HG2.400.SS	Ø 13-21 mm	400 mm
HG2.600.SS	Ø 13-21 mm	600 mm
HG3.400.SS	Ø 17-31 mm	400 mm
HG3.600.SS	Ø 17-31 mm	600 mm
HG4.400.SS	Ø 20-36 mm	400 mm
HG4.600.SS	Ø 20-36 mm	600 mm
HG5.400.SS	Ø 27-52 mm	400 mm
HG5.600.SS	Ø 27-52 mm	600 mm
HG6.400.SS	Ø 45-70 mm	400 mm
HG6.600.SS	Ø 45-70 mm	600 mm
HG7.400.SS	Ø 72-110 mm	400 mm
HG7.600.SS	Ø 72-110 mm	600 mm



DERC Hose Whip Checks



SPECIFICATIONS

Part No.	Description
WR1	Whip Check 3 mm Model A
WR2	Whip Check 6 mm Model B1/2"
WR3	Whip Check 24" Red Dog
GS4-950	Whip Check 4 mm with Kevlar and Polyester
GS6-1000	Whip Check 6 mm with Kevlar and Polyester



DERC Warning Sign Water Jetting



EASY TO STORE AND CARRY

Safety first! This warning sign is ideal to secure your job site. The sign is easy to fold out and the spring mechanism prevents collapsing unintentionally.

A weather-resistant galvanized steel frame ensures high stability. The folded sign is easy to store in its supplied protective cover. The edge length of this warning sign is 70 cm.



Scan for
more info



FEATURES

- Weather-resistant signal covering made of robust plastic fabric
- High visibility
- Sturdy tripod, fully galvanized steel
- High level of stability thanks to specially shaped feet
- Easy to store and carry

APPLICATION

- Securing job site when water jetting

Part No. VE.10108



SAYING LIVES



TST Sweden Authorized Dealer
DERC Salotech recommends the workplace safety solutions and protective clothing of TST as the best available in the world. If you are interested in TST products please contact us. As a TST dealer we can supply you with the full range of products.

CALL US +31 186 - 62 14 84

High Pressure Guns

High Pressure Guns

Scan for
more info



THE PERFECT GUNS FOR MANUAL HIGH PRESSURE CLEANING

DERC Salotech offers a wide range of hand guns for high pressure water jetting.

Hand Guns

The range of hand guns includes both Dump Style and Dry Shut-In Style options, offering solutions for high-pressure applications up to 2800 bar. Dump Style hand guns allow operators to quickly relieve pressure by releasing water when the trigger is disengaged, ensuring safety and ease of operation. In contrast, Dry Shut-In Style hand guns maintain pressure without water discharge, reducing spillage and waste.

All hand guns feature durable components, ergonomic designs with adjustable body pads or shoulder supports, and quick 30-second field-replaceable cartridges to minimize downtime. These hand guns are available in various configurations, including single or dual trigger options, making them versatile tools for industrial and maritime applications and provide more flexibility for the operator.

FEATURES

- Available in various configurations
- Dump style or dry shot
- Up to 2800 bar
- Quick cartridge replacement (30 sec.)
- Ergonomic design

APPLICATION

- Manual water jet cleaning

High Pressure Guns Color Codes



1000 bar

Both standard and field repairable guns are offered in single or dual trigger, dump or dry shut-in style. All guns are color coded in green for the 1000 bar rating.



1400 bar

Both standard and field repairable guns are offered in single or dual trigger, dump or dry shut-in style. All guns are color coded in blue for the 1400 bar rating.



2800 bar

Both standard and field repairable guns are offered in single or dual trigger, dump or dry shut-in style. All guns are color coded in orange for the 2800 bar rating.

High Pressure Foot Valves

High Pressure Foot Valves

Scan for
more info

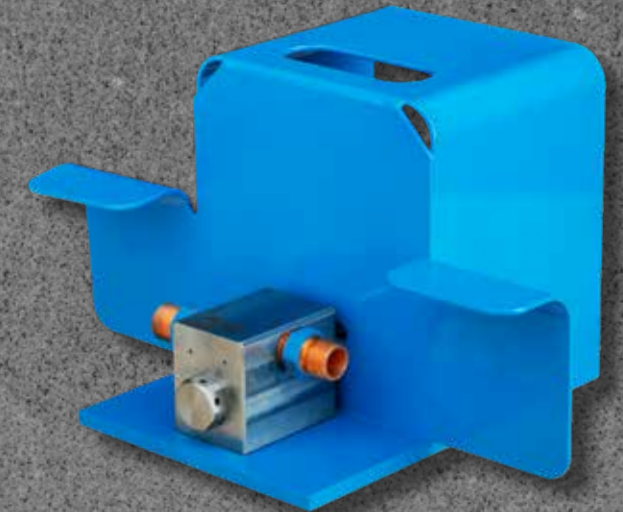
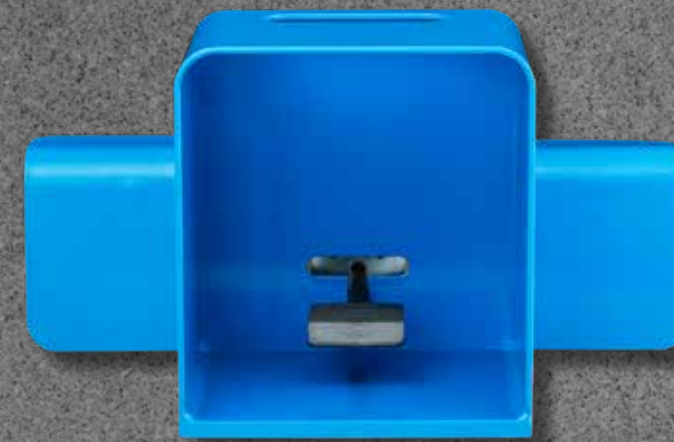
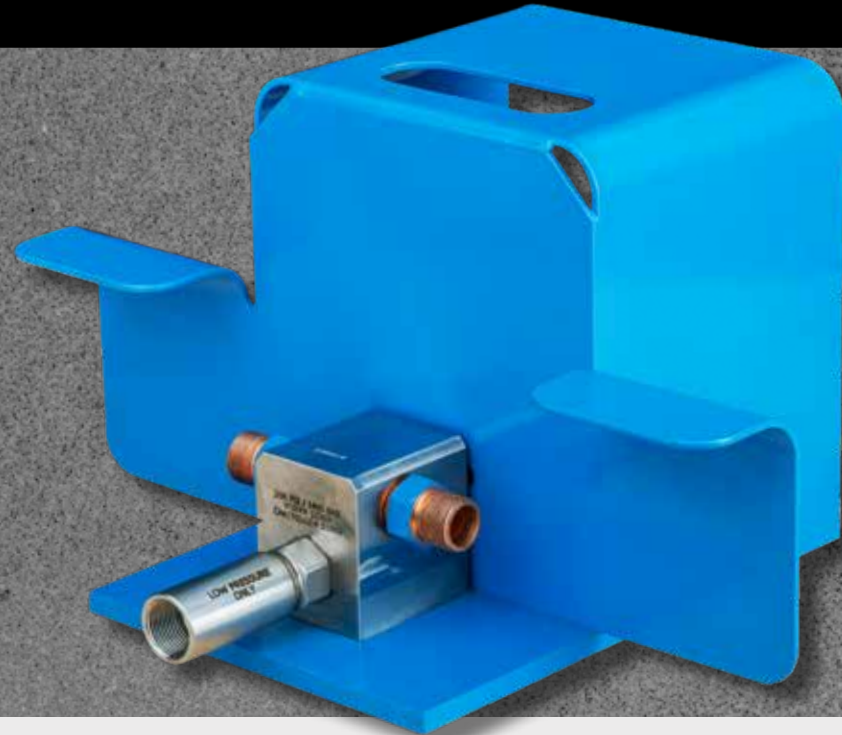

THE PERFECT FOOT VALVES FOR MANUAL HIGH PRESSURE CLEANING

We offer two high-quality foot valves that are perfect for a variety of (manual) high pressure tube cleaning applications: the Dry Shut Foot Valve and the Dump Style Foot Valve.

Dry Shut Foot Valve

The Dry Shut Foot Valve is ideal for situations where water spillage and disposal are concerns. This valve does not dump water when the trigger is released, meaning there is no unwanted water leakage. This makes it perfect for applications where water management is crucial.

Dump Style Foot Valve

The Dump Style Foot Valve also offers complete pressure control but with a different approach. When activated, the dump valve (spring return) of the foot control closes and the system is pressurized. When deactivated, the water is dumped by the dump valve, ensuring that the used hose or high pressure gun is never unintentionally pressurized.

FEATURES

- Safety cage protects the operator
- Built-in "wings" protect the HP end fittings
- Threaded diffuser to route dump water for collection or disposal (dump style only)
- Quick replacement of cartridge (30 seconds)

APPLICATIONS

- Manual high pressure cleaning
- Flex lancing
- Pressure control

DRY SHUT FOOT VALVES

Model	Max. Pressure	Max. Flow	Inlet & Outlet Connection	Dimensions
DCFSi-15	1000 bar	130 lpm	1/2" NPT Female	200 x 375 x 286 mm
DCFSi-20	1400 bar		20K Port Female	223 x 424 x 235 mm

DUMP STYLE FOOT VALVES

Model	Max. Pressure	Max. Flow	Inlet & Outlet Connection	Dimensions
DCF-15-1/2"	1000 bar	130 lpm	1/2" NPT Female	200 x 375 x 338 mm
DCF-15-3/4"	1000 bar	285 lpm	3/4" NPT Female	200 x 375 x 343 mm
DCF-15-1"	1000 bar	475 lpm	1" NPT Female	200 x 375 x 393 mm
DCF-20	1400 bar	130 lpm	20K Port Female	223 x 424 x 235 mm
DCF-20 Mag	1400 bar	190 lpm	3/4" MP Female	223 x 424 x 235 mm
DCF-40	2800 bar		40K Port Female	223 x 424 x 235 mm

DERC Multi Tool Valve UHP

DERC Multi Tool Valve UHP

Scan for
more info

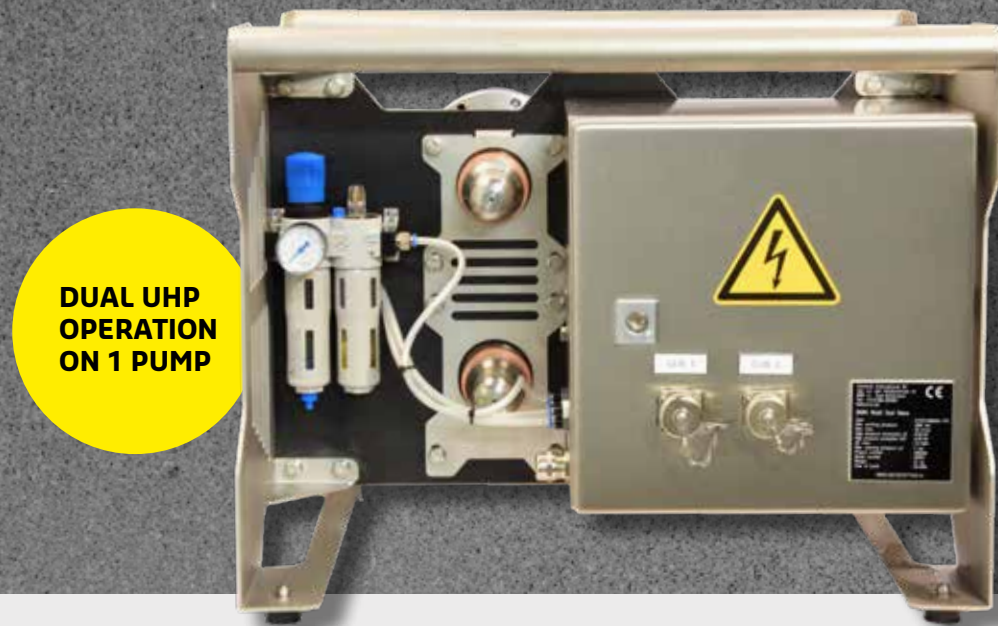

**DUAL UHP
OPERATION
ON 1 PUMP**



SPECIFICATIONS

Part No.	D.MVT.2800EXI-7PS
Max. Pressure	2800 bar
Max. Flow	52 lpm (26 l per consumer)
Connection Inlet	Inlet 9/16" HP (M30x2 or 1 1/8" UNF in combination with M14 of 9/16" LH) or M34x2 in combination with M18x1.5 LH
Connection Outlet	2 x 9/16", 2 x 3/8" HP out for 5 mm UHP hose
Input Voltage	24VDC
Input Air	7 bar
Signal Out	2 x 7 Pin Connector Steel 2 channel intrinsic safe EXI - for consumers*
Signal In	1 x 7 Pin Connector Steel 2 channel intrinsic safe EXI - unit pressure on/off*

* Other connectors available on request

DUAL UHP OPERATION ON ONE PUMP

The DERC Multi Tool Valve is especially designed and built to make it possible to work with two high pressure guns or foot valves with electric control on one high pressure unit, without influencing the pressure in the guns.

Up to 2800 bar

The DERC Multi Tool Valve has a maximum working pressure of 2800 bar and can be attached to any high pressure unit. This requires external air pressure and 24VDC power.

Easy to transport

The DERC Multi Tool Valve is mounted on a stainless steel frame, which can be installed next to or on the high pressure unit. It is easy to transport with the two integrated handles.

FEATURES

- Very easy to operate, plug and play system
- To use in combination with every high pressure unit
- Suitable for one or two high pressure guns or foot valves with electric control
- Easy maintenance

APPLICATIONS

- Manual high pressure cleaning
- Flex lancing
- Pressure control

CALL US +31 186 - 62 14 84

DERC Insert Nozzles



Insert Nozzles Up To 1500 Bar

DERC high-pressure waterjetting insert nozzles are an essential tool used in various industries for effective and efficient industrial cleaning applications. We offer a complete range made of high-quality hardened stainless steel, with a maximum pressure of up to 1500 bar, providing a durable and versatile solution.



SPECIFICATIONS

Model	Thread	Length	Available Diameters	Part No.
DI 18	1/8" NPT	13 mm	Ø 0.50 - Ø 3.40	DI 18-xxx
DI 14	1/4" NPT	29 mm	Ø 0.50 - Ø 5.00	DI 14-xxx
DSI 14	1/4" NPT	17 mm	Ø 0.50 - Ø 4.20	DSI 14-xxx

DERC RN Nozzle



RotoCar Cleaning Nozzle Up To 1500 Bar

The RN-nozzle is specially designed for cleaning pipe systems with our Rotocar Cleaning System with a maximum working pressure of 1500 or 3000 bar. The nozzle can be specially configured for your operating condition per order. The nozzle is suitable for the cleaning of clogged pipes. Our special stages pyramid design enhances the effectiveness of your impact.



SPECIFICATIONS

Connection	Thread	Orifices	Length	Diameter	Part No.
M24x1.5	Male	3xØ1.7 mm	53 mm	Ø 32 mm	RN.029.31.xxx
M22x1.5	Female	2xT4	74 mm	Ø 45 mm	RN145.2T4.14F
M22x1.5	Female	4xT4	93 mm	Ø 45 mm	RN145.4T4.14F
M22x1.5	Female	20xT4	108 mm	Ø 69 mm	RN169.20T4.14F

DERC Nozzle Drivers



Up To 1500 Bar

The DERC range of Nozzle Drivers, also called pusher units, can be used behind every nozzle or even between hoses to give extra thrust. The DERC Nozzle Driver range goes standard up to 1500 bar/ 22K. Nozzle Drivers are a stock item with a short delivery time.



SPECIFICATIONS

Connection D1	Connection D2	Diameter	No. of jets / Ø jets	Part No.
M7x1 M	M7x1 F	Ø 10 mm	2 x Ø 0.8 mm	ND.10.07.02
M7x1 M	M7x1 F	Ø 10 mm	3 x Ø 0.8 mm	ND.10.07.03
M7x1 M	M7x1 F	Ø 10 mm	4 x Ø 0.8 mm	ND.10.07.04
1/8" BSP M	1/8" BSP F	Ø 10 mm	2 x Ø 0.8 mm	ND.12.18.02
1/8" BSP M	1/8" BSP F	Ø 12 mm	3 x Ø 0.8 mm	ND.12.18.03
1/8" BSP M	1/8" BSP F	Ø 12 mm	4 x Ø 0.8 mm	ND.12.18.04
1/4" BSP M	1/4" BSP F	Ø 16 mm	2 x Ø 0.8 mm	ND.16.14.02
1/4" BSP M	1/4" BSP F	Ø 16 mm	3 x Ø 0.8 mm	ND.16.14.03
1/4" BSP M	1/4" BSP F	Ø 16 mm	4 x Ø 0.8 mm	ND.16.14.04
1/4" BSP M	1/4" BSP F	Ø 22 mm	2 x Ø 0.9 mm	ND.22.14.02
1/4" BSP M	1/4" BSP F	Ø 22 mm	3 x Ø 0.8 mm	ND.22.14.03
M24x1.5 M	M24x1.5 F	Ø 30 mm	2 x Ø 1.0 mm	ND.30.24.02
M24x1.5 M	M24x1.5 F	Ø 30 mm	3 x Ø 1.2 mm	ND.30.24.03
M24x1.5 M	M24x1.5 F	Ø 30 mm	4 x Ø 1.0 mm	ND.30.24.04
M22x1.5 M	1/4" BSP F	Ø 31 mm	2 x Ø 0.8 mm	ND.31.03.14
M22x1.5 M	M24x1.5 M	Ø 31 mm	3 x Ø 1.0 mm	ND.31.03.24
M22x1.5 M	1/4" BSP F	Ø 31 mm	4 x Ø 0.8 mm	ND.31.03.14
M36x2 M	M36x2 M	Ø 50 mm	4 x M6	ND.50.36M.36M

Insert Fan Jet Nozzle 602



Model 602, Up To 750 Bar / 10K

The Insert Flat Fan Jet Nozzle is designed from hard and stainless steel. The flat fan gives you a high effective result. Insert Flat Fan Nozzle Model 602 is standard available from diameter 0,80 mm till 2,70 mm, other diameters are on request available.



SPECIFICATIONS

Part No.	Diameter	Length	Angle	Thread
602.xxx	From Ø 0,80 mm till 2,70 mm	22 mm	From 15° till 60°	1/4" NPTM

Insert Round Jet Nozzle 546



Model 546, Up To 750 Bar / 10K

The Insert Round Jet Nozzle model 546 is designed from hard and stainless steel. It is standard available from 0,80 diameter till 2,10 mm diameter. Other diameters are on request available.



SPECIFICATIONS

Part No.	Diameter	Length	Angle	Thread
546.xxx	From Ø 0,80 mm till 2,10 mm	22 mm	-	1/4" NPT M

Fan Jet Nozzle 08 & 019



Model 08 & 019, Up To 2000 Bar

The Fan Jet Nozzle Model 08 and 019 are made from hard and stainless steel. The strong fan gives you a high effective result. The Fan Jet Nozzle Model 08 and 19 are standard available from 0,25 diameter till 5,0 mm diameter, other diameters are on request available. The nozzle is used for a lot of jetting gun applications.



FAN JET NOZZLE MODEL 08

Part No.	Diameter	LxØD/Ød (mm)	Angle
08.xxx	From Ø 0,25 mm till 5,00 mm	20x14/8	From 10 till 45°

FAN JET NOZZLE MODEL 19

Part No.	Diameter	LxØD/Ød (mm)	Angle
19.xxx	From Ø 0,25 mm till 5,00 mm	20x12/8	From 15 till 45°

ADAPTOR 19 -> 08

Part No.	Special Tool	Part No.	Description
FSP.04.01	AD.04.01	OR.04.19	O-ring model 4/19
		OR.01.08	O-ring model 1/8
		BA.01.08	B-ring Type 1/8

O-RING BACK UP RING

Round Jet Nozzle 01 & 04



Model 01 & 04, Up To 2000 bar / 29K

Made from hard and stainless steel, the long and sharp jet gives you a high effective result. Standard available from 0,40 diameter till 5,0 mm diameter, other diameters are on request available. This nozzle is also known as: Pencil jet, Hammelmann type A, Drop in nozzle, Uraca model Type P.



STANDARD ROUND JET NOZZLE MODEL 01

Part No.	Diameter	LxØD/Ød (mm)
01.xxx	From Ø 0,40 mm till 5,00 mm	24x14/8

STANDARD ROUND JET NOZZLE MODEL 04

Part No.	Diameter	LxØD/Ød (mm)
04.xxx	From Ø 0,40 mm till 5,00 mm	24x12/8

ADAPTOR 04 -> 01

O-RING BACK UP RING

Part No.	Special Tool	Part No.	Description
AD.04.01	FSP.04.01	OR.04.19	O-ring model 4/19
		OR.01.08	O-ring model 1/8
		BA.01.08	B-ring Type 1/8

Ceramic Nozzles



Up To 3000 bar

The continuous shape of the ceramic insert produces a very high efficiency and an unbeatable impactfull jet. This nozzles have also a very good performance in the field of runway rubber removal, road marking removal and road surface retexturing.



SPECIFICATIONS

Part No.	Connection	Max. Pressure
Ceramic Nozzle 909-CER	Insert	3000 bar
Ceramic Nozzle 916-CER	Insert	3000 bar
Ceramic Nozzle 950-CER	Insert	3000 bar
Ceramic Nozzle 952-CER	Insert	3000 bar
Ceramic Nozzle 965-CER	M10	3000 bar
Ceramic Nozzle 972-CER	3/8"-24 UNF	3000 bar

Sapphire Nozzles



The extensive sapphire product range offers the right type of nozzle for most customer-specific system on the market. All sapphires are checked for scratches, cracks and flowrate. Through the guide sleeve we achieve an optimal water flow to the sapphire and the stone holder reduces the through hole, and serves the safety if a sapphire shatters.



SPECIFICATIONS

Part No.	Connection	Max. Pressure
Sapphire Nozzle 030	M3	1000 bar
Sapphire Nozzle 040	M4	1000 bar
Sapphire Nozzle 046	M4	3000 bar
Sapphire Nozzle 060	M6	1000 bar
Sapphire Nozzle 065	M6	3000 bar
Sapphire Nozzle 080	M8	1000 bar
Sapphire Nozzle 082	M8	2000 bar
Sapphire Nozzle 165	M6	1000 / 2500 bar

Sapphire Nozzle 270



SPECIFICATIONS

Part No.	Connection	Max. Pressure
Sapphire Nozzle 270	Insert	4000 bar



Sapphire Nozzle 916



SPECIFICATIONS

Part No.	Connection	Max. Pressure
Sapphire Nozzle 916	Insert	3000 bar



Sapphire Nozzle 950



SPECIFICATIONS

Part No.	Connection	Max. Pressure
Sapphire Nozzle 950	Insert	3000 bar



Sapphire Nozzle 952



SPECIFICATIONS

Part No.	Connection	Max. Pressure
Sapphire Nozzle 952	Insert	3000 bar



Sapphire Nozzle 964



SPECIFICATIONS

Part No.	Connection	Max. Pressure
Sapphire Nozzle 916	M10	3000 bar



Sapphire Nozzle 965



SPECIFICATIONS

Part No.	Connection	Max. Pressure
Sapphire Nozzle 965	M10	3000 bar



Sapphire Nozzle 972



SPECIFICATIONS

Part No.	Connection	Max. Pressure
Sapphire Nozzle 972	3/8" - 24 UNF	3000 bar



Sapphire Nozzle 976



SPECIFICATIONS

Part No.	Connection	Max. Pressure
Sapphire Nozzle 976	7/16" - 20 UNF	3000 bar



Round Jet Nozzle 226



Model 226, Up To 1000 bar / 15K

The Round Jet Nozzle Model 226 is made from hard and stainless steel. The round jet gives you a high effective result. The Round Jet Nozzle Model 226 is standard available from 0,8 mm diameter till 5 mm diameter, other diameters are on request available. This nozzle is also known as: high speed nozzle, Bunddüse, Hammelmann Type L.



SPECIFICATIONS

Part No.	Diameter	LxØD/Ød (mm)
226.xxx	From Ø 0,80 mm till 5 mm	28x17/12,5

DERC Round Jet Nozzle HSN



Model HSN, Up To 1000 bar / 15K

The Round Jet Nozzle Model HSN is made from hard and stainless steel. The round jet produces a focused water jet combined with a large max. flow. It is a perfect match for tank cleaning heads. The Round Jet Nozzle Model HSN is standard available from 1,4 mm diameter till 4,4 mm diameter, other diameters are on request available. This nozzle is also known as: high speed nozzle or Bunddüse.



SPECIFICATIONS

Part No.	Diameter	LxØD/Ød (mm)
HSN.xxx	From Ø 1,4 mm till 4,4 mm	26x17/9

Nozzle Inserts Metric



Up To 3000 bar / 43K

The Nozzle Insert Metric is designed from hardened and stainless steel. The constant key quality gives you a high power and focused water jet.



SPECIFICATIONS

Part No.	Thread	Type	Max. Pressure	Application
400.114.xxx	M4	Fan Jet Nozzle	3000 bar - 43K	Papermill industry
400.115.xxx	M4	RJ Nozzle	3000 bar - 43K	
400.116.xxx	M6	RJ Nozzle	1500 bar - 22K	
400.117.xxx	M3	RJ Nozzle	3000 bar - 43K	Special nozzle

DERC Nozzle Holder for Paper Industry



Designed for paper mill suction roll maintenance

Able to hold 5x M10 model P965 (round-jet) or F965 (fan-jet) nozzles, this holder streamlines the cleaning process while maximizing efficiency. With a seamless M24 Quick Lock connection, our nozzle holder ensures swift and hassle-free assembly. This facilitates quick maintenance turnaround times, minimizing downtime and optimizing overall productivity.



Fan Jet Nozzle F965



Fanjet nozzle used for paper mill felt cleaning application. Used in combination with nozzle retainer M10 and Metso type manifold, see DERC Nozzle Holder for Paper Mill Applications (see above).



SPECIFICATIONS

Part No.	Diameter	LxØD/Ød (mm)	Angle
F965.xxx.xx	From 0,20 till 0,70 mm	21.7x5/8	15° / 30°

Paper Mill Machine Nozzles PMN



The PMN nozzles for the paper industry are characterized by their very robust design and the self-produced synthetic ruby nozzle stone. A long service lifetime and a constant jet quality are guaranteed.



Edge Trim Nozzles RSD



These high-performance RSD nozzles for paper cutting are characterised by their long lifetime, efficiency and quality. The extensive product range offers the right type of nozzle for most paper cutting systems. The ruby inserts used especially for this ensure that the nozzles enjoy a long service life and a constant jet performance.



Paper Mill MSD Nozzles



Multi-Insert nozzle holder for paper mill production. Used during paper production for felt cleaning application. Connection M18 male with O-ring sealing, 2-9 long sharp jets and sapphire inserts for effective cleaning.



SPECIFICATIONS

Type	Diameter	Part No.
6740 MSD-2	Ø 0.20, 0.25, 0.30	6740 MSD-2.020-6740 MSD-2.030
6740 MSD-3	Ø 0.20, 0.25, 0.30	6740 MSD-3.020-6740 MSD-3.030
6740 MSD-4	Ø 0.20, 0.25, 0.30	6740 MSD-4.020-6740 MSD-4.030
6740 MSD-6	Ø 0.20, 0.25, 0.30	6740 MSD-6.020-6740 MSD-6.030
6740 MSD-9	Ø 0.125, 0.15, 0.175, 0.20	6740 MSD-9.0125-6740 MSD-9.020

DERC Adapters, Manifolds & Nozzle Holders

DERC Adapters, Manifolds & Nozzle Holders



DESIGNED & MANUFACTURED TO YOUR SPECIFICATIONS

Engineering

DERC Salotech offers a full range of adapters, manifolds and nozzle holders that can be custom made to your specifications. Our engineers will assist you in the development, design and manufacturing of the most effective, innovative and safe cleaning solutions for your organisation or your specific industrial cleaning objective.

Manufacturing

In our factory you will find a fine selection of craftsmen and specialists with a deep knowledge of water jetting technology. This team (guided by our engineers and engineering department) has the insights, competences and aspiration to guarantee a technical perfect product for you.



Stock Items

Besides custom made solutions, we also have a large stock of standard products that can be shipped with short delivery times.



REDUCING ADAPTERS

DOUBLE FITTINGS

SOCKETS

MANIFOLDS

NOZZLE HOLDERS & CAPS

DERC Reducing Adapters



The tables below shows just a sample of the reducing adapters we provide. It consists of our standard product range that we can deliver quickly from stock. But there are endless possibilities with thread type and size that can be engineered and manufactured in our factory.



ADAPTER MALE X MALE

Thread 1	Thread 2	Max. Pressure	Part No.
M7x1	5/16" UNF	1000 bar	NI.07MV.516UM
M22x1.5	M24x1.5	1500 bar	NI.22M.24M
M22x1.5	M24x1.5 flat	1500 bar	NI.24M.24MV
M24x1.5	3/4" MP	1500 bar	NI.24M.M12M
M24x1.5	3/4" NPT	1000 bar	NI.24M.34NM
M24x1.5	M36x2	1500 bar	NI.24M.36M
M24x1.5	M36x2 flat	1500 bar	NI.24M.36MV

ADAPTER MALE X MALE

Thread 1	Thread 2	Max. Pressure	Part No.
1/8" BSP	1/4" BSP	1500 bar	NI.18M.14M
1/4" BSP	M24x1.5	1500 bar	NI.14M.24M
1/4" BSP	3/8" BSP flat	1500 bar	NI.14M.38MV
1/4" BSP	13/16 UNF	1500 bar	NI.14M.M9M
3/8" BSP	1/2" NPT	1000 bar	NI.38M.12NM
3/8" BSP	M24x1.5	1250 bar	NI.38M.24M
3/8" BSP flat	M24x1.5	1250 bar	NI.38MV.24M
1/2" BSP	M22x1.5	1500 bar	NI.12M.22M
1/2" BSP	M24x1.5	1500 bar	NI.12M.24M

ADAPTER MALE X MALE

Thread 1	Thread 2	Max. Pressure	Part No.
9/16" UNF	M24x1.5	1500 bar	NI.M9M.24M

DERC Reducing Adapters



ADAPTER MALE X MALE

Thread 1	Thread 2	Max. Pressure	Part No.
1/4" NPT	1/4" BSP	1000 bar	NI.14NM.14M
3/8" NPT	M24x1.5	1000 bar	NI.38NM.24M
1/2" NPT	1/2" BSP	1000 bar	NI.12NM.12M
1/2" NPT	M24x1.5	1000 bar	NI.12NM.24M
3/4" NPT	M36x2	1000 bar	NI.34NM.36M

ADAPTER MALE X FEMALE

Thread 1	Thread 2	Max. Pressure	Part No.
M24x1.5 M	3/4" NPT F	1000 bar	NI.24M.34NF

ADAPTER MALE X FEMALE

Thread 1	Thread 2	Max. Pressure	Part No.
1/8" BSP F	M24x1.5 M	1500 bar	NI.18FV.24M
1/4" BSP F	3/8" NPT M	1000 bar	NI.14FV.38NM
1/4" BSP M	3/8" BSP F	1500 bar	NI.14MV.38F
1/4" BSP F	M24x1.5 M	1500 bar	NI.14FV.24M
1/4" BSP F	3/8" BSP M flat	1500 bar	NI.14FV.38MV
3/8" BSP F	M24x1.5 M	1500 bar	NI.38FV.24M
1/2" BSP F	M24x1.5 M	1500 bar	NI.12FV.24M

ADAPTER MALE X FEMALE

Thread 1	Thread 2	Max. Pressure	Part No.
1/16" NPT F	M7x1 M	1000 bar	NI.116NF.07M
1/4" NPT M	1/4" BSP F	1000 bar	NI.14NM.14FV
1/2" NPT F	M24x1.5 M	1000 bar	NI.12NF.24M
3/4" NPT F	M36x2 M	1000 bar	NI.34NF.36M

ADAPTER FEMALE X FEMALE

Thread 1	Thread 2	Max. Pressure	Part No.
1/4" NPT	1/4" BSP	1000 bar	NI.14NF.14F
1/4" NPT	3/8" BSP	1000 bar	NI.14NF.38F

DERC Double Fittings



The tables below shows just a sample of the double fitting adapters we provide. It consists of our standard product range that we can deliver quickly from stock. But there are endless possibilities with thread type and size that can be engineered and manufactured in our factory.



DOUBLE FITTINGS BSP CONICAL

Connection	Max. Pressure	Part No.
1/4"	1500 bar	NI.14M.14M
3/8"	1500 bar	NI.38M.38M
1/2"	1500 bar	NI.12M.12M

DOUBLE FITTINGS BSP FLAT FACE

Connection	Max. Pressure	Part No.
1/4"	1500 bar	NI.14MV.14MV
3/8"	1500 bar	NI.38MV.38MV

DOUBLE FITTINGS METRIC

Connection	Max. Pressure	Part No.
M7x1	1500 bar	NI.07M.07M
M22x1.5	1500 bar	NI.22M.22M
M24x1.5	1500 bar	NI.24M.24M
M36x2	1500 bar	NI.36M.36M

DOUBLE FITTINGS NPT

Connection	Max. Pressure	Part No.
1/4"	1000 bar	NI.14NM.14NM
1/2"	1000 bar	NI.12NM.12NM

DOUBLE FITTINGS UNF

Connection	Max. Pressure	Part No.
5/16" - 24 UNF	1000 bar	NI.516UM.516UM

DERC Manifolds



High pressure fittings

For all kind of applications DERC Salotech manufactures multi port manifolds, y-pieces and custom made solutions. The table below shows just a sample of what we can provide. It consists of our standard product range that we can deliver quickly from stock. But there are endless possibilities with thread type and size that can be produced in our factory.



OPTIONAL ARMS AND HEADS

Connection	Size	Max. Pressure	Part No.
3x 3/4" NPT F (Y)	Ø 110 x 44 mm	1000 bar	MA.343NF
3x 9/16" MP F (Y)	Ø 110 x 44 mm	1500 bar	MA.3916MP
3x 1/2" BSP F (Y)	Ø 80 x 35 mm	1000 bar	MA.123F
1x M36x2 F-3x 1/4" NPT F	Ø 55 x 70 mm	1000 bar	MA.3-TLE36F

DERC Sockets



The tables below shows just a sample of the sockets we can provide. It consists of our standard product range that we can deliver quickly from stock. But there are endless possibilities with thread type and size that can be engineered and manufactured in our factory.



SOCKETS BSP FLAT FACE

Connection	Max. Pressure	Part No.
1/4"	1500 bar	NI.14FV.14FV
3/8"	1250 bar	NI.38FV.38FV
1/2"	1500 bar	NI.12FV.12FV

SOCKETS METRIC FLAT FACE

Connection	Max. Pressure	Part No.
M7x1	1500 bar	NI.M7FV.M7FV
M24X1.5	1500 bar	NI.24FV.24FV

SOCKETS NPT

Connection	Max. Pressure	Part No.
1/4"	1000 bar	NI.14NF.14NF

DERC Nozzle Holders & Caps



DERC Salotech manufactures a wide range of stainless steel nozzle holders and caps with a working pressure up to 2000 bar. The tables below shows just a sample of what we can provide. It consists of our standard product range that we can deliver quickly from stock, both nozzle holders for nozzles and all kind of tank cleaning heads. There are endless possibilities with thread type and size that can be produced in our factory.



NOZZLE HOLDERS

Nozzle Type	Thread	Length	Spanner	Max. Pressure	Part No.
T4/T19 (3/8" BSP M)	3/8" BSP F	55 mm	23 mm	1200 bar	4050.6.38F
T4/T19 (3/8" BSP M)	3/8" NPT F	60 mm	27 mm	1000 bar	4050.6.38NF
T4/T19 (3/8" BSP M)	13/16" UNF	55 mm	27 mm	1500 bar	4050.6.916UF
T4/T19 (3/8" BSP M)	9/16" - 18 UNF	50 mm	27 mm	1500 bar	4050.6.916Y
T1/T8 (1/2" BSP M)	3/8" NPT F	50 mm	27 mm	1000 bar	4050.8.38NF
T1/T8 (1/2" BSP M)	9/16" UNF-18	50 mm	24 mm	2000 bar	4050.8.916Y
T1/T8 (1/2" BSP M)	M14x1.5 F	50 mm	24 mm	2000 bar	4050.8.M14Y

NOZZLE CAPS

Nozzle Type	Thread	Length	Spanner	Max. Pressure	Part No.
T4/T19	3/8" BSP F	29 mm	27 mm	1500 bar	4050.2.005
T1/T8	1/2" BSP F	34 mm	28 mm	2000 bar	4050.2.007
T226	1/2" BSP F	62 mm	32 mm	1250 bar	W3508
T4/T19	M24x1.5	40 mm	32 mm	1200 bar	W4149



DERC Rupture Disc Holder



SAFETY DEVICE FOR HIGH PRESSURE PUMP SYSTEMS

The DERC Rupture Disc Holder is a safety device for high pressure units and systems. When the pressure gets higher than the rupture disc permits, the rupture disc will break out, which results in an immediate system pressure drop. Therefore the installation can never exceed the maximum pressure of the mounted bursting disc. The DERC Rupture Disc Holder holds a rupture disc.

FEATURES

- Quick delivery time
- 1000, 1500 and 3000 bar
- 3 types of connections
- Made of stainless steel
- Also a portable version

SPECIFICATIONS

Part No.	Max. Pressure	Connection	Disc Type
D.RDH.1000	1000 bar	1/2" NPT	1/2"
D.RDH.1500	1500 bar	13/16" - 16 UNF (9/16" MP)	1/4"
D.RDH.3000	3000 bar	1 1/8" - 12 UNF (9/16" HP)	1/4"

*Other connections and pressures are available on request.

Scan for more info



Rupture Disc



A Rupture Disc Holder holds a rupture disc. When the system pressure exceeds the maximum pressure of the rupture disc, it will break the rupture disc. As a result the water can now drain through the drain holes at the top of the Rupture Disc Holder.

A protective hood is installed over the drain holes is, which prevents the water from spraying around uncontrolled. The Rupture Disc can be placed in every Rupture Disc Holder. We offer two sizes: 1/2" and 1/4".



RUPTURE DISC 1/2"

Part No.	Max. Pressure (bar)	Max. Pressure (kpsi)
RD-12-06K	400	6000
RD-12-08K	550	8000
RD-12-10K	700	10000
RD-12-12K	850	12000
RD-12-14K	950	14000
RD-12-16K	1100	16000
RD-12-18K	1260	18000
RD-12-20K	1400	20000

RUPTURE DISC 1/4"

Part No.	Max. Pressure (bar)	Max. Pressure (kpsi)
RD-14-18K	1260	18000
RD-14-24K	1655	24000
RD-14-27K	1861	27000
RD-14-29K	2000	29000
RD-14-35K	2414	35000
RD-14-40K	2758	40000
RD-14-45K	3103	45000
RD-14-50K	3448	50000
RD-14-56K	3860	56000

DERC Automated Solutions Rail ASR

DERC Automated Solutions Rail ASR

Scan for more info



AUTOMATED SOLUTIONS RAIL 4"



SPLICE TUBE



WEDGE BOLTS



ASR + AST 2.5"



ROLLERS WITH BEARING

YOUR BASIS FOR AUTOMATED SOLUTIONS

For automated high pressure solutions the DERC Automated Solutions Rail (ASR) is the perfect basis. The slotted rail is strong and reliable.

Sizes

The ASR is available as 2.5" or 4" and comes in different lengths up to 6000 mm.

Connecting Multiple Rails

The DERC Splice Tube connects the 2.5" and 4" aluminium rails quick and effective and is easy to fit together with the Wedge Bolts.



FEATURES

- Strong and reliable
- Endless possibilities
- Maintenance free rollers
- 2.5" or 4" model

APPLICATIONS

- Powered tractors (AST)
- Powered swivels
- X-Y positioning

ACCESSORIES ASR

Accessory	Part No.
Roller with bearing	ASR-055
Splice tube	ASR-006
Rail clamp	ASR-060-R10
Bolt M10 for rail clamp	ASR-060-M10
End plate	ASR-152
Insert 4"	ASR-070
Wedge bolt slotted	ASR-008-BU
Wedge Bolt 2.5"	ASR-008-BUC-2.5
Wedge Bolt 4"	ASR-008-BUC
Splice Tube 2.5"	ASR-006-2.5

AUTOMATED SOLUTIONS RAIL

Size	Part No.
2.5" ASR	ASR-2.5-6000
4" ASR	ASR-4-6000

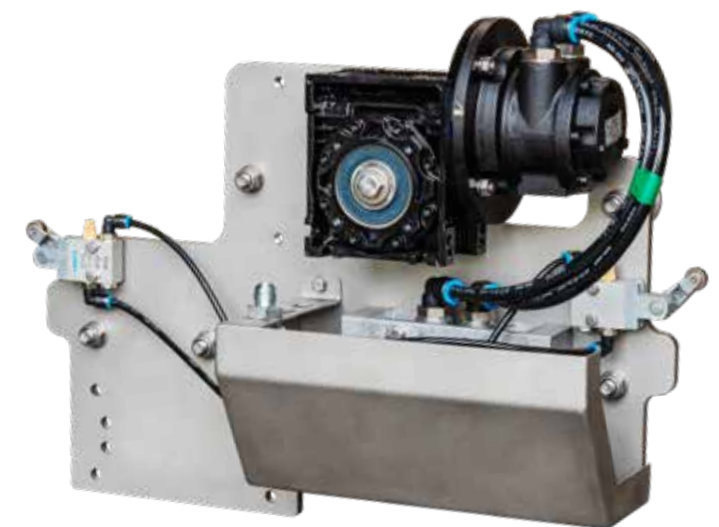

Automated Solutions Tractor 4"

Automated Solutions Tractor

We offer air or hydraulic powered tractors (2.5" and 4" versions) for the ASR. These tractors, equipped with end switches for directional control, can be fitted with various water jetting tools. Both tractor and tool speeds are adjustable from a control panel.

DERC Pre-Filter

DERC Pre-Filter

Scan for more info



PROTECT YOUR HIGH PRESSURE EQUIPMENT

The DERC Pre-filter filters your suction water and protects your valuable high pressure equipment. A filtration of 800 to 30 microns is possible by the use of two various filter elements. The stainless steel filter elements are easy to clean.

The Pre-filter comes standard with one outer and inner filter element. An individual filter element comes with a stainless steel filter mesh. A wide range of filter elements makes a filtration of 800 to 30 microns possible.

The water is filtered from the outside to the inside. The Pre-filter is equipped with a flush valve to clean your Pre-filter during operations.

Connect DERC Pre-filters to realise optimal filtration capacity. You can easily link a second or third Pre-filter, doubling or tripling your filter capacity. Just hook on to the clips on the frame and off you go. You can also connect Pre-filters in order to bypass a filter.

FEATURES

- Strong and reliable
- Endless possibilities
- Maintenance free rollers
- 2.5" or 4" model

APPLICATIONS

- Powered tractors (AST)
- Powered swivels
- X-Y positioning

SPECIFICATIONS

Single Pre Filter Ass.	FL.15000.AS
Max. Pressure	10 bar
Max. Capacity	max. 30 m3/h
Connection	Storz nok 81
Couplers for Duplex System (Set)	FL.15200.AS

Inner Filter Element FL12001.xxx
30/50/75/100/130/300/435 µm

Outer Filter Element FL12002.xxx
75/100/130/200/300/435/800 µm



DERC Lances



DERC Salotech offers a wide range of stainless steel (ultra) high pressure tubing till 4000 bar. We supply a wide range of tube sizes, ranging from from 1/4" (6.35 mm) up to 1" (33.4 mm). We cut and thread the lances to suit your application. Lengths available till 35 ft. (10.6 m), longer on request. All lances are delivered with certificates.



WE HAVE A STOCK OF THE FOLLOWING TUBE SIZES:

Connection	Max. Pressure	Outside Diameter	Inside Diameter
1/4" UHP	4000 bar	6,35 mm	2,26 mm
3/8" UHP	4000 bar	9,53 mm	3,2 mm
9/16" UHP	4000 bar	14,3 mm	4,75 mm
3/8" MP	1500 bar	9,53 mm	5,15 mm
9/16" MP	1500 bar	14,3 mm	7,92 mm
3/4" MP	1500 bar	19,05 mm	11,1 mm
5/16"	1500 bar	7,9 mm	4,6 mm
1/8"	1000 bar	10,3 mm	5,58 mm
1/4"	1500 bar	13,7 mm	7,92 mm
3/8"	1500 bar	16,7 mm	10,75 mm
1/2"	1000 bar	21,34 mm	11,78 mm
3/4"	1000 bar	26,67 mm	15,55 mm
1"	1000 bar	33,4 mm	24,3 mm
24x7	1500 bar	24 mm	10 mm



CALL US +31 186 - 62 14 84

DERC Stingers



Stingers are stainless steel high pressure ridged lances which are used when flex lancing. They are used to prevent boomeranging and to prevent nozzle and hose damage by whipping of the hose exiting the tube. For safe and easy flex lancing we manufacture all necessary stingers.



STINGERS UP TO 1000 BAR

Connection	Diameter	Part No.
5/16" UNF	ø 10 mm	VL516MFxxxx
1/16" NPT	ø 10.5mm	VL116NMFxxxx
1/8" NPT	ø 12 mm	VL18NMFxxxx
1/4" NPT	ø 16 mm	VL14NMFxxxx
1/2" NPT	Hexagon 27 mm	VL12NMFxxxx
M24x1.5	Hexagon 30 mm	VL24MFxxxx
3/4" NPT	ø 40 mm	VL34NMFxxxx

STINGERS UP TO 1500 BAR

Connection	Diameter	Part No.
M7x1	ø 9.4 mm	ST07MFxxxx
1/4" UNF LH	ø 9.5 mm	ST14UMFxxxx
1/8" BSP	ø 12 mm	ST18MFxxxx
3/8" UNF LH	ø 13 mm	ST38UMFxxxx
1/4" BSP	ø 16 mm	ST14MFxxxx
9/16" UNF LH	ø 18 mm	ST916UMFxxxx
M24x1.5	Hexagon 30 mm	ST24MFxxxx
M36x2	Hexagon 46 mm	ST36MFxxxx

STINGERS UP TO 2800 BAR

Connection	Diameter	Part No.
3/8" UNF	ø 12.7 mm	ST38UHMFxxxx
9/16" UNF	ø 19 mm	ST916UHMFxxxx
M14x1.5	ø 19 mm	STM14UHMFxxxx

DERC Short 90° Elbows



The tables below shows just a sample of the short 90° elbows we provide. It consists of our standard product range that we can deliver quickly from stock. But there are endless possibilities with thread type and size that can be engineered and manufactured in our factory.



WE HAVE A STOCK OF THE FOLLOWING SHORT 90° ELBOWS:

Angle	Thread	Size	Max. Pressure	Part No.
90°	1/2" BSP M/F	49x45x30 mm	1500 bar	360.1453
90°	M24x1.5 M/F	52x50x30 mm	1500 bar	360.1455
90°	M36x2 M/F	67x65x36 mm	1500 bar	360.1456
90°	1/2" NPT - M24x1.5	55x50x30 mm	1000 bar	360.1452
90°	9/16" MP - M24x1.5	55x50x30 mm	1500 bar	360.1457

Quick Connectors



Built for durability and convenience, these connectors offer a quick and safe connection for your high pressure hoses up to 1000 bar.



QUICK CONNECTORS

Plug	Max. Pressure	Part No.
3/8" NPT F	1000 bar	S34-32504-001
1/2" BSP F	1000 bar	516001-BSPF
1/2" NPT F	1000 bar	516001
3/4" NPT F	800 bar	516054
1" NPT F	700 bar	516070

DERC Long Radius Elbows



45° and 90° stainless steel long radius elbows
For high pressure water jetting installations and all other applications DERC Salotech manufactures a complete range of high pressure stainless steel elbows (up to 3000 bar). These elbows have less pressure loss due to the bended tubing and design.



ELBOW M24 SPECIFICATIONS

Part No.	45° / 90°	Connection	Thread	Max. Pressure
ELB.45.24M.24SW	45°	M/F	M24x1.5	1000 bar
ELB.45.24SW.24SW	45°	F/F	M24x1.5	1000 bar
ELB.90.24M.24M	90°	M/M	M24x1.5	1000 bar
ELB.90.24SW.24SW	90°	F/F	M24x1.5	1000 bar
ELB.90.24M.24SW	90°	M/F	M24x1.5	1000 bar

ELBOW M36 SPECIFICATIONS

Part No.	45° / 90°	Connection	Thread	Max. Pressure
ELB.45.36SW.36SW	45°	F/F	M36x2	1500 bar
ELB.90.36M.36M	90°	M/M	M36x2	1500 bar
ELB.90.36SW.36SW	90°	F/F	M36x2	1500 bar
ELB.90.36M.36SW	90°	M/F	M36x2	1500 bar
ELB.45.36M.36SW	45°	M/F	M36x2	1500 bar

OTHER ELBOW SPECIFICATIONS

Part No.	45° / 90°	Connection	Thread	Max. Pressure
ELB.90.01NM.36SW	90°	M/F	1" NPT M36x2	800 bar
ELB.90.42M.42M	90°	M/M	M42x2	1000 bar
ELB.90.42SW.42SW	90°	F/F	M42x2	1000 bar
ELB.90.42M.42SW	90°	M/F	M42x2	1000 bar

Connectors & Cables



Connecting Electricity

DERC Salotech offers a wide range of 4 or 7 pin connectors (soldered or crimped), accessories and cables. See the tables below for the full range of products.



STANDARD CONNECTORS, 7 PIN SOLDER CONNECTION

Description	Part No.
Connector 7 pin M steel	EL.01103
Connector 7 pin F steel	EL.01108
Chassis part 7 pin M steel	EL.01101
Chassis part 7 pin F steel	EL.01102

STANDARD CONNECTORS, 7 PIN, CRIMP CONNECTION

Description	Part No.
Connector 7 pin M steel	EL.01103.001
Connector 7 pin F steel	EL.01108.001
Chassis part 7 pin M steel	EL.01101.001
Chassis part 7 pin F steel	EL.01102.001
Spare/replacement pin M	030-8586-000
Spare/replacement pin F	031-8555-110

EXTRA ACCESSORIES FOR STANDARD CONNECTORS

Description	Part No.
Protection plug 7 pin	EL.01106
Protection plug 7 pin	EL.01107
Seal for Chassis part	EL.075-8515-0
Cable nut with pull release PG13 (incl. EL.116 336)	EL.100.2015
Cable nut with pull release PG11	EL.100.2007
Seal ring PG13 5-8 mm	EL.116.335
Seal ring PG13 5-13 mm	EL.116.336

SKINTOP BENDING CONNECTION

Description	Part No.
Skin bending connection PG11	EL.530.15620
Skin bending connection PG13	EL.530.15630
Skin bending connection M20x1.5	EL.530.17630

OTHER CONNECTORS

Description	Part No.
Connector 4 pin M steel	EL.401326
Connector 4 pin F steel	EL.401327
Connector 7 pin M plastic	EL.3104.001
Connector 7 pin F plastic	EL.3105.001
Chassis part 7 pin M plastic	EL.3106.001
Chassis part 7 pin F plastic	EL.3107.001
Connector 4 pin M plastic	EL.3108.001
Connector 4 pin F plastic	EL.3109.001
Chassis part 4 pin M plastic	EL.3110.001
Chassis part 4 pin F plastic	EL.3111.000
Connector 4 pin M steel crimp	EL.401326.001
Protection cap for EL.401326.001	EL.401326.002
Connector 4 pin F steel crimp	EL.401327.001
Protection cap for EL.401327.001	EL.401327.002

ELECTRICAL CABLE 7 WIRE

Description	Part No.
Electric cable 4 wire PUR 4 x 0.75	EL.082.1020
Electric cable 7 wire PUR 7 x 0.75	EL.70000

Emergency Stops, Remotes & Reels



Cutting Off Power in Case of Emergency

DERC Salotech offers emergency stops and remote on/off switches to cut off power instantly. See the tables below for the available options.



REMOTE CONTROL

Description	Part No.
Remote control On/Off + emergency switch and 7 pin M-F chassis part connectors, 2 channel	EL.2000.002
Remote control On/Off + Emergency switch with 3 m cable and 7 pin M steel connector, 2 channel	EL.6000.032

CABLE REEL

Description	Part No.
Cable reel with 50 m cable, emergency switch and 7 pin M steel connector, 2 channel	EL.4000.502
Cable reel with 100 m cable, emergency switch and 7 pin M steel connector, 2 channel	EL.3000.102

EMERGENCY STOP

Description	Part No.
Emergency switch with 7/1 m cable and 7 pin M-F steel connectors, 2 channel	EL.5000.232

Sewer Cleaning Nozzles

Sewer Cleaning Nozzles

Scan for more info



FAST AND EFFECTIVE CLEANING OF SEWER PIPES

For sewer cleaning applications DERC Salotech offers a wide range of nozzles with interchangeable carbide, ceramic or steel inserts. All nozzles are made by hardened steel, some of them by hardened stainless steel.

Rotating & Vibration Action Nozzles

For the removal of calcified obstructions or limestone sediments, we offer rotating & vibration action nozzles.

Desanders Nozzles

The main characteristics of the desanding nozzles are the high weight and the orientation of the jets towards the bottom of the pipe, so as to concentrate all the water flow of the pump in the thrust and simultaneous removal of mud, sand and sediment deposits. DERC Salotech recommends the use of rotary swivels to connect these heavy nozzles to the high pressure hoses. These nozzles are supplied with interchangeable ceramic or carbide (W) inserts. The latter ones are recommended with water recycling systems.

FEATURES

- Rugged stainless steel construction
- Easy adjustable rotation speed
- With sharp hard hitting jets
- Max. working pressure 400 bar

APPLICATIONS

- General sewer cleaning
- Grease removal
- Root cutting



Root Cutting Nozzles

For the removal of roots, rust, limestone and unsuccessful liners, we offer rotating nozzles with chains. Chain nozzles should always be used with chains and centralizer suitable for the pipe diameter.

Nozzles for Cleaning Domestic Drains (DN30-200)

The nozzles in this category satisfy the most ordinary cleaning needs in domestic and condominium pipelines, combining materials (stainless steel and not), weight, small dimensions and thrust jet inclinations. Normally these nozzles have 1/8", 1/4", 3/8", and 1/2" female threads but they are also available with male threads.



DERC Sewer Razor

DERC Sewer Razor

Scan for more info



SPEED CONTROLLED SEWER CLEANING NOZZLE

The DERC Sewer Razor is the first sewer tool on the market with an easy to adjust rotating speed, making it the most versatile tool available.

Rotation Speed

It's unique speed controlled swivel is supported by a rugged centralizer to withstand hard deposits. The speed of rotation is easy to set manually to create the right tool for each job.

Jetting Heads

The jetting head of the DERC Sewer Razor is equipped with one front jet offset for unplugging and four jets for cleaning and pulling. The DERC Sewer Razor can be outfitted with two different heads; one for a high capacity pump and one for a smaller pump. Other heads for descaling and custom made models are possible.

FEATURES

- Rugged stainless steel construction
- Easy adjustable rotation speed
- With sharp hard hitting jets
- Max. working pressure 400 bar

APPLICATIONS

- General sewer cleaning
- Grease removal
- Root cutting
- Final finishing before camera inspection

SPECIFICATIONS

Max. Flow	Dimensions	Connection	Nozzles	Rotation Speed	Max. Pressure
380 lpm	Ø 125 x 213 mm	1" BSP female (other connections on request)	DSI 14 1/4"NPT with flow stabilizer	Adjustable up to 300 rpm	400 bar



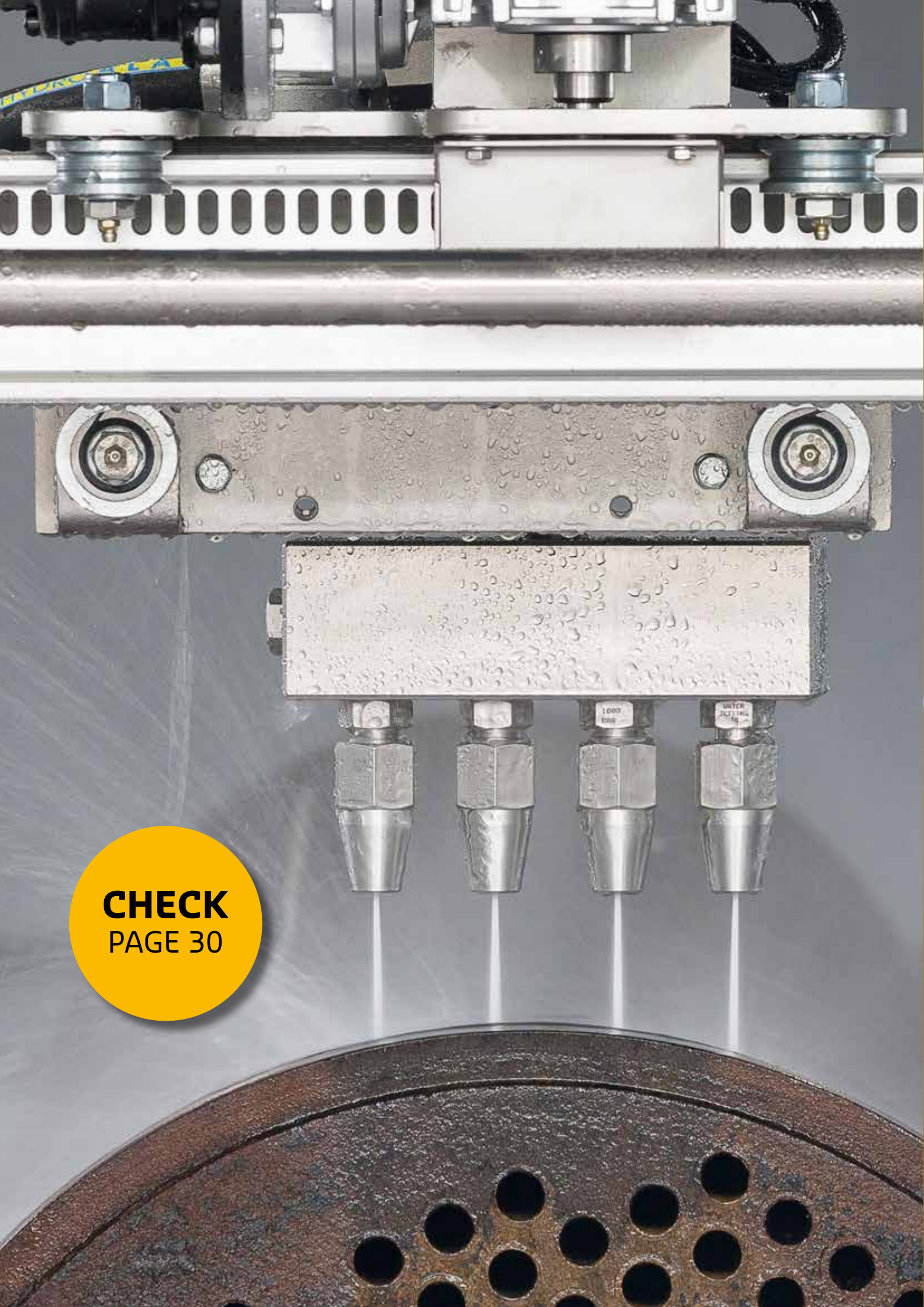

CHECK
PAGE 30

CHECK
PAGE 12

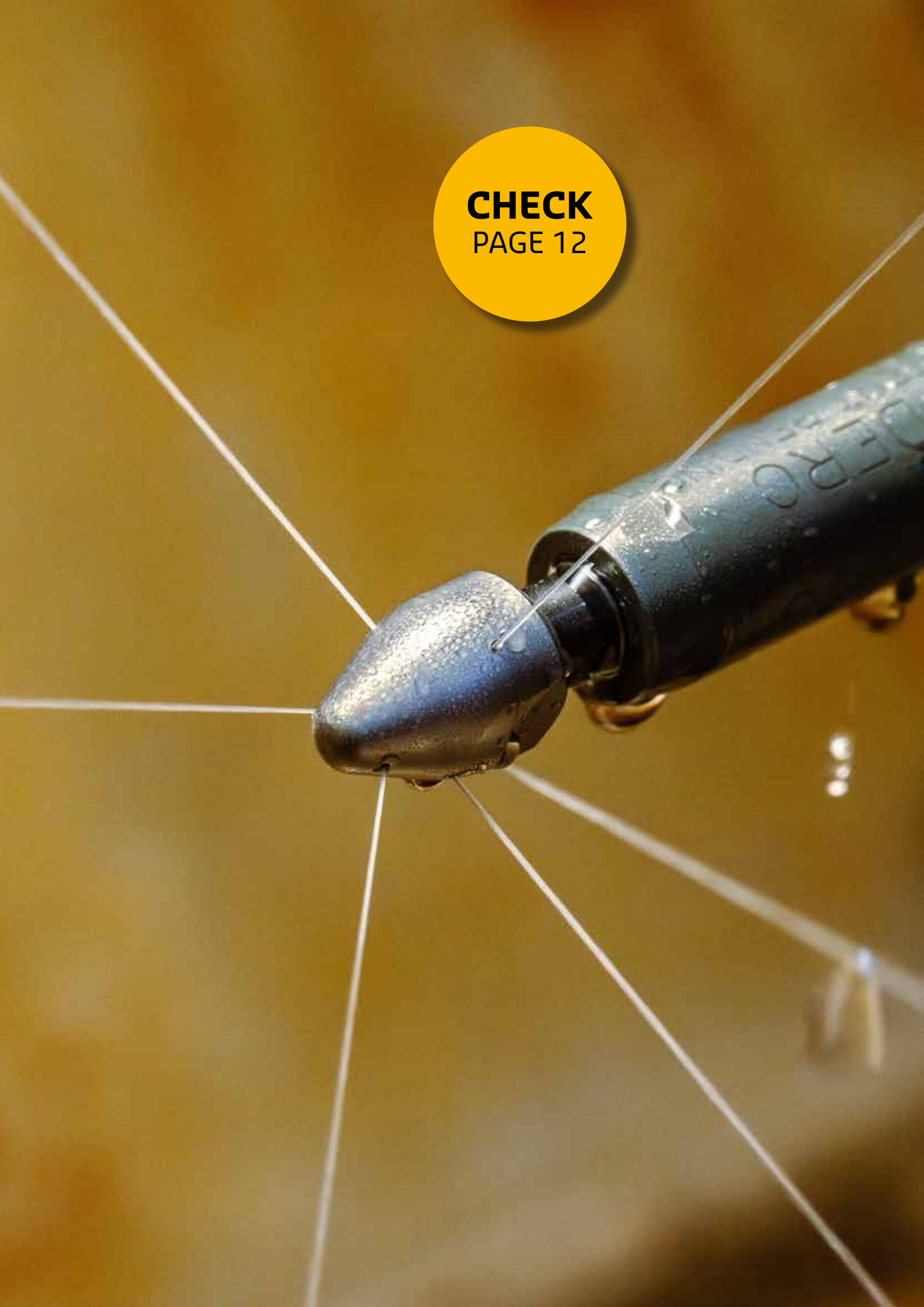



**JAN VAN DER HEIJDENSTRAAT 44
3261 LE OUD-BEIJERLAND
THE NETHERLANDS**

**DERCSALOTECH.NL
+31 186 - 62 14 84**

DERC SALOTECH DEALER INFORMATION: